



www.regulus.eu



RegulusHBOX K

Installation and Operation Manual | **EN**
RegulusHBOX K 106 RTC 3/1

RegulusHBOX K

CONTENTS

A. GENERAL INFORMATION	5
A1. Safety Instructions	5
A2. Application, Description	5
A2.1. Heating	5
A2.2. Cooling	5
A2.3. Description	6
A3. Components	7
A4. Internal Hydraulic Connection	8
A5. Parameters	9
B. INSTALLATION, CONNECTION	11
B1. Dimensions	11
B2. Installation Site Requirements	12
B3. Installation	12
B4. Hydraulic Connection	13
B4.1. Hydraulic Variant with one heating circuit	14
B5. Electrical Wiring	15
B5.1. Cable Entry	15
B5.2. Terminal Block	16
B5.3. Complete Inner Wiring Diagram	17
B5.4. Wiring Diagram of M&R Peripherals to RegulushBOX K	18
B5.5. Connection and Adjustment of Optional Accessories - room sensor/unit, thermostat	19
B6. Pre-commissioning Inspection	20
C. SETTINGS USING THE MAIN DISPLAY	21
C1. Main menu	21
C1.1. Settings for HEATING	22
C1.2. Settings for HOT WATER	22
C1.3. Settings for DHW RECIRCULATION	23
C1.4. Settings for HEAT PUMP	23
C1.5. Settings for AUX. SOURCE	23
C1.6. Settings for VENTILATION	23
C1.7. Settings for REGULUS ROUTE	24
D. HOW TO SET ACCESS TO CONTROLLER WEBSITE	25
D1. Access to the controller via local network	25
D2. Access to the controller directly via Ethernet cable	25
D3. How to connect via IR Client mobile application	29
E. SETTING THE CONTROLLER THROUGH WEB BROWSER	30
E1. Home Screen (HOME)	30
E2. Tiles for Heating and Hot Water	31
E3. Tiles for Hot Water Recirculation and Ventilation	32
E4. Display of the Diagram (DIAGRAM)	32
E5. Heating Zone Menu (HEATING)	33

E6. Heating Zone Settings (Zone 1 to 6)	33
E6.1. Room Temperature Settings	34
E6.2. Time Program Settings	34
E6.3. Summer/Winter Function Settings (blocks heating in summer).....	35
E6.4. OTC Curve Settings	35
E6.5. Cooling Settings	36
E7. ThSt Zone.....	36
E8. Pool Heating	36
E9. Holidays	37
E10. DHW Menu (HOT WATER)	37
E10.1. Domestic Hot Water	37
E10.2. Setting the desired temperatures	37
E10.3. Hot Water Recirculation Settings	38
E10.4. Anti-Legionella	38
E11. Sources Menu (SOURCES)	38
E11.1. Heat Pump	38
E11.2. Solar Heating	39
E11.3. PV (Photovoltaic system)	40
E11.4. Fireplace, Solid Fuel Boiler	41
E11.5. RegulusHBOX K Electric Heating Element.....	42
E12. Other Settings Menu (OTHER)	43
E12.1. Inputs and Outputs	43
E12.2. Access and Password	43
E12.3. General Settings	43
E12.4. Function Overview	43
E12.5. Fault History	43
E12.6. HRV Zone /HRV Zone 2.....	43
E12.7. Universal Outputs (Universal functions)	45
E12.8. RegulusRoute	46
E13. Manual Access Menu (MANUALS)	46
F. ADJUSTING THE CONTROLLER THROUGH THE SERVICE DISPLAY	47
F1. Controller Input	47
F2. Overview of Parameters Displayed on the Service Display	47
F2.1. Basic Display	47
F2.2. Zone Display (zone 1, zone 2)	48
F2.3. Solar Thermal System Display	49
F2.4. Display of Hot Water Zone	49
F2.5. Display of Heat Pump, Heat Pump Cascade	49
F2.6. Display with Firmware Version and Release Date	51
F2.7. Controller in Factory Settings	51
F2.8. Select the Desired Setting (menu)	51
F3. User Settings	52
F3.1. Heating Zones	52
F3.2. HRV Zone	52

F3.3. Time Programs	53
F3.4. Weather Compensating Heating Curves	53
F3.5. Heat Pump Control	53
F3.6. HP Faults	53
F3.7. Other Faults	53
F3.8. Settings of DHW Heating	54
F3.9. Settings of Thermal Store Heating	54
F3.10. Settings of DHW Recirculation	54
F3.11. Statistics	54
F3.12. Operating Data	54
F3.13. Other	54
F3.14. Date and Time Settings	55
F3.15. RegulusRoute - Service Connection Parameters	55
F4. Additional Modules.....	55
F4.1. Fireplace Module	55
F4.2. UNI Module, UNI Module 2	55
G. MAINTENANCE	56
G1. Maintenance by the User	56
G2. Removing the Front Cover.....	56
G3. Removing the Wiring Cover	57
G4. Professional Maintenance	57
G5. Discontinuing Operation	58
G6. Recycling / Disposal	58
H. SERVICING	58
H1. Fault Indication	58
H2. Record of Repairs and Inspections	59

A. GENERAL INFORMATION

This Installation and Operation Manual forms an integral part of the product. Before starting any work, read this manual and keep it accessible at all times. Should you lose the manual, you can download the current version in pdf format from the website www.regulus.eu.

A1. Safety Instructions

- **This appliance should only be used by persons who have been properly instructed in the safe use of the appliance and understand the risks involved. The appliance should not be used by children and persons with limited physical, sensory or mental abilities or with insufficient experience and knowledge. It is expressly forbidden for children to play with the appliance!**
- **The hydraulic connection** of RegulusHBOX K shall be carried out by a professionally qualified person in compliance with the applicable standards and regulations.
- Only persons with electrical qualification are permitted to remove the wiring cover.
- **All electrical installation work must be carried out by a professionally qualified person, in accordance with this Manual and in compliance with the applicable standards and regulations.**
- Do not tamper with the internal wiring of RegulusHBOX K, it is complete from the production.
- **Before starting work on the electrical installation, it is necessary to disconnect RegulusHBOX K from the power supply!**
- **The controller integrated in RegulusHBOX K in no way replaces the safety elements of the heating system or the hot water system.** These safety elements must be installed in accordance with the applicable standards and regulations. Carry out the installation according to the design and make sure all prescribed safety elements are installed.
- The setting of the controller and the connection of optional accessories must be carried out in accordance with the instructions given in this manual.

A2. Application, Description

A2.1. Heating

RegulusHBOX K indoor unit is designed for space and DHW heating from an inverter RTC heat pump (RTC 6i or RTC 13e) in an enamelled hot water storage tank.

A2.2. Cooling

Cooling a building with a heat pump

When combined with RegulusHBOX K unit, the RTC heat pump can be used for cooling supposed the working fluid temperature is not below 18°C. Cooling at lower temperatures will require a special hydraulic connection and must be solved in connection with the entire heating/cooling circuit. If you require this method of cooling the building, kindly contact the export department of Regulus.

A2.3. Description

The operation of the RegulusHBOX K unit and the connected heating and DHW systems is controlled by an integrated smart controller, which is fully wired from the factory. This controller is equipped with its own website (webserver) permitting remote control via a computer web browser or via a smartphone or tablet with the Regulus IR Client app installed (Android and iOS versions available).

The RegulusHBOX K unit includes an enamelled RGC-type hot water tank for DHW heating, an auxiliary heat source fitted with a 6 kW heating element switched in 2 kW steps, and a circulation pump for a heat pump and heating circuit.

Switching of the heat pump between heating and DHW is provided by an integrated three-way zone valve with actuator.

Information about the current operating status can be read on the control unit with graphic display located on the front cover of the RegulusHBOX K unit. The connection cable of the control unit is not connected at the factory (to prevent it from being torn out during installation). During installation it must be plugged into the counter-piece marked „Display“ on the wiring cover. If necessary, the control unit can be relocated to the living area of the house, where it can also act as a room temperature and humidity sensor (connected with a JYSTY 1x2x0.8 cable). In this case, it is necessary to install a blind plug (code 18248 - not included) in place of the control unit.

Basic elements of RegulusHBOX K indoor unit

- IR RegulusHBOX K Controller with remote access from a computer or a mobile app.
- Control unit with graphical display, English menu, that can be used as a room unit (two-wire connection).
- RGC 170 hot water tank with enamelled inner surface, integrated heat exchanger for DHW heating and an electronic anode rod.
- Wilo Para 25/8 iPWM1 circulation pump for the heat pump circuit and heating circuit.
- 6 kW heating element, switched in 2 kW steps (max. output can be limited in the controller menu).
- Output for another 6 kW heating element switched in 2 kW steps.
- Three-way zone ball valve for heat pump switching between space and DHW heating.
- Heating system safety valve.
- Drain valve for heating and DHW systems.
- Electric wiring incl. terminal block for easy connection of a heat pump and other accessories incl. basic element protection.
- Heating water temperature and pressure sensor, DHW temperature sensor.
- Outdoor temperature sensor.
- Ball valve with filter and magnet

Accessories (not included in supply)

- Safety kit for cold water piping, incl. check valve, safety valve, pressure gauge, branch for connecting expansion vessel/recirculation and branch for heating water topping up - for codes see the Catalogue.
- CSE TV pump station for DHW recirculation - for codes see the Catalogue.
- Expansion vessel for heating systems - for codes see the Catalogue.
- DHW expansion vessel - for codes see the Catalogue.
- Blind Plug and Frame for RegulusBOX K when the control unit with display is used as a room unit - code 18248.

A3. Components

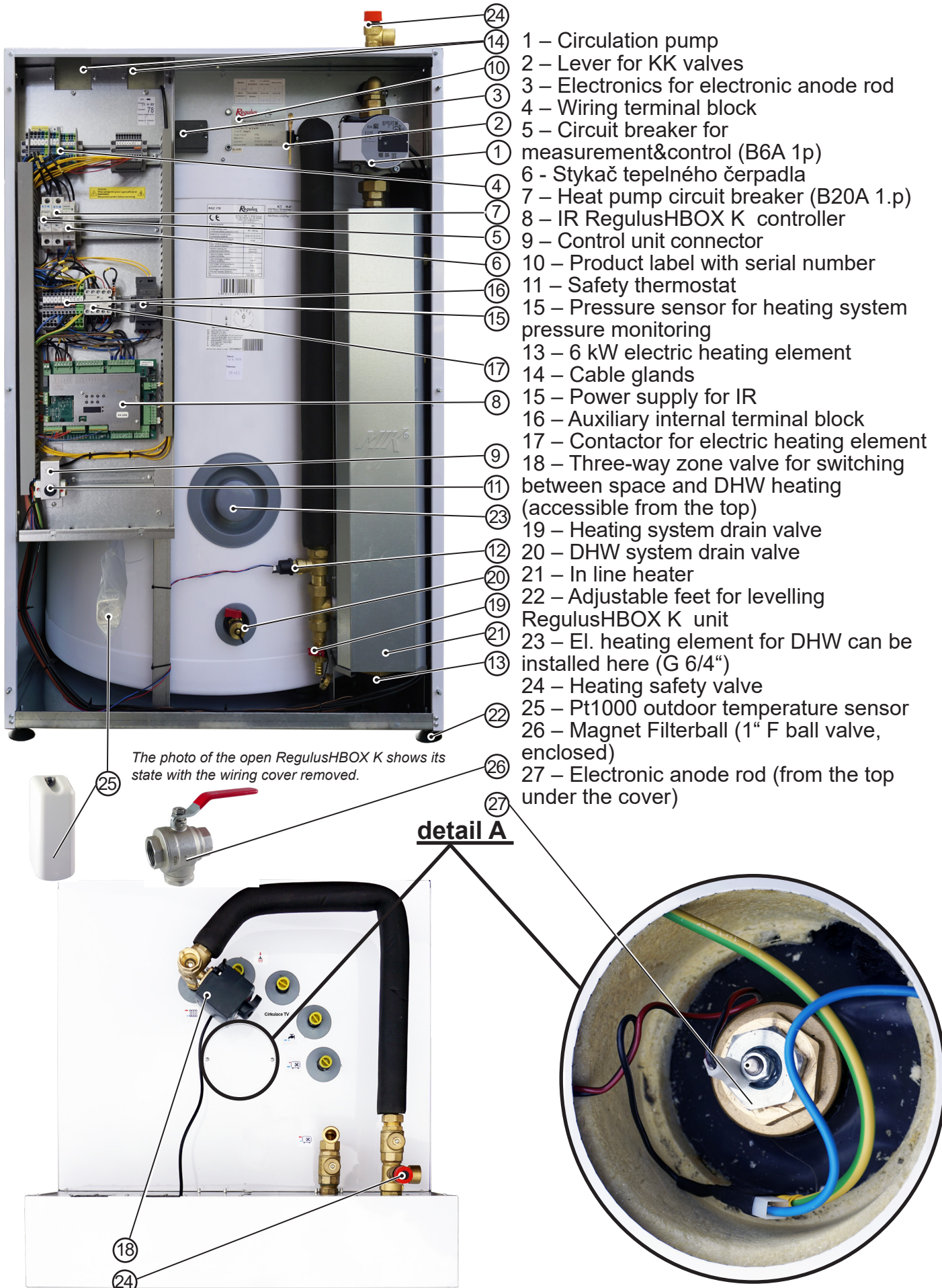

A4. Internal Hydraulic Connection

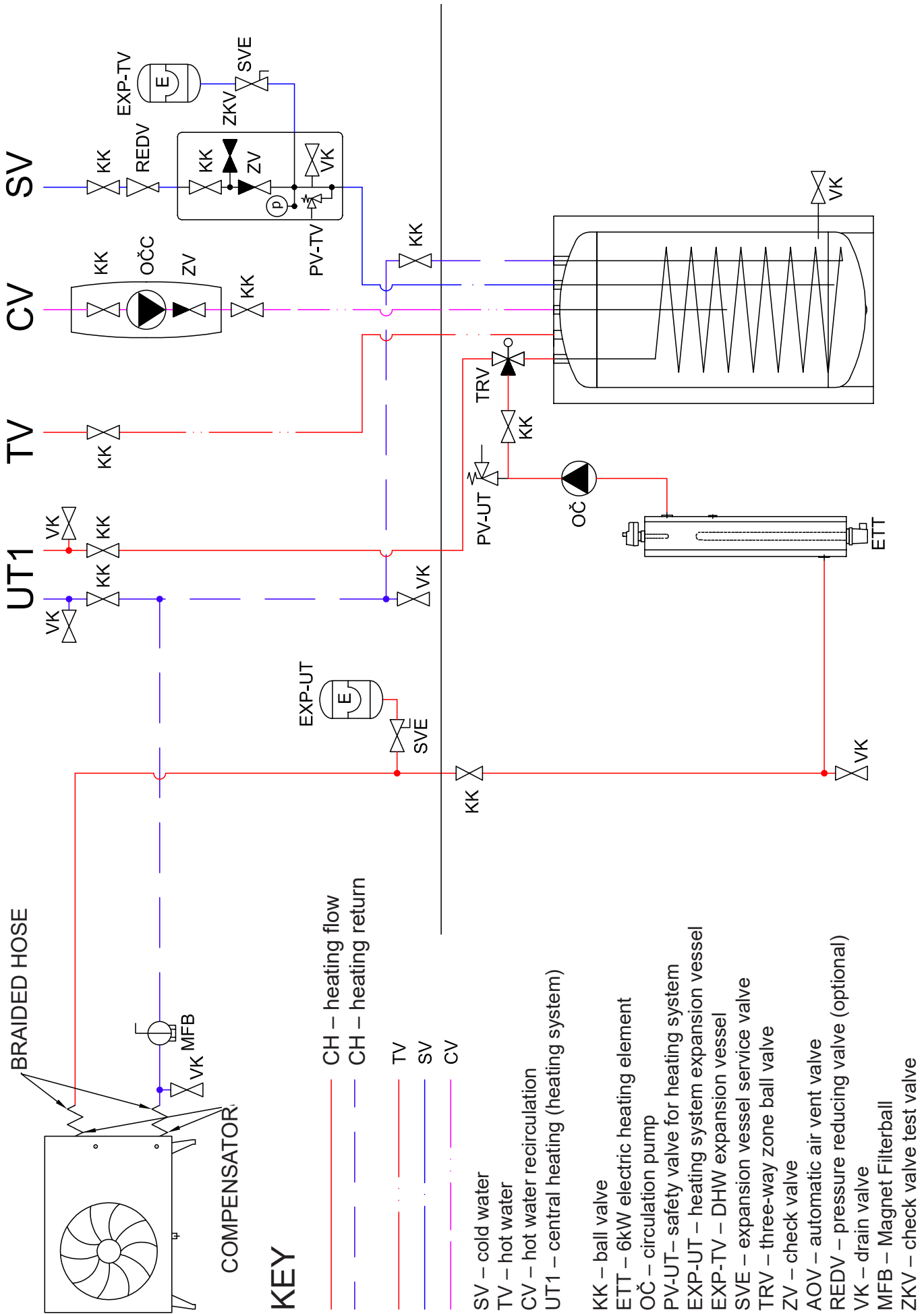

- KEY**
- CH – heating flow
 - - - CH – heating return
 - TV
 - SV
 - CV
- SV – cold water
 - TV – hot water
 - CV – hot water recirculation
 - UT1 – central heating (heating system)
- KK – ball valve
 - ETT – 6kW electric heating element
 - OČ – circulation pump
 - PV-UT – safety valve for heating system
 - EXP-TV – heating system expansion vessel
 - EXP-TV – DHW expansion vessel
 - SVE – expansion vessel service valve
 - TRV – three-way zone ball valve
 - ZV – check valve
 - AOV – automatic air vent valve
 - REDV – pressure reducing valve (optional)
 - VK – drain valve
 - MFB – Magnet Filterball
 - ZKV – check valve test valve

A5. Parameters

Technical Data	
Total tank volume	173 l
Total fluid volume in tank	166 l
Fluid volume in DHW heat exchanger	7 l
DHW heat exchanger surface area	1.6 m ²
Fluid working temperature	18–90 °C
Max. working pressure – heating system	3 bar
Min. working pressure – heating system	0.5 bar
Max. working pressure – DHW	6 bar
Ambient temperature	5–40 °C
Max. relative humidity	80 % non condensing
Safety valve set pressure – heating system	3 bar
Safety valve seat cross section	132 mm ²
Safety valve discharge coefficient	0.3
3-way valve actuator run time	15 s
Heat loss (tank 60 °C/ambient 20 °C)	87 W
Total weight without water	166 kg
Total weight with water	350 kg
Overall dimensions (W x H x D)	750 x 1222 x 833 mm
Tipping height (without safety valve connected)	1390 mm

Electric Data	
Power supply	3/N/PE ~ 400 / 230 V 50 Hz
Max. cross section of power cable	4 mm ² (stranded) / 6 mm ² (solid)
Nominal power input	6.2 kW (without a heat pump connected)
Heating element	1 x 6 kW (3 x 2 kW – 230 V) – possibility to connect a second heating element 6 kW
IP rating	IP20
Circuit breaker for heat pump	B 20A 1p
Circuit breaker for measurement and control	B 6A 1p

Connectivity, Memory Card	
Ethernet 100 Mbit/s	2 x
USB for connecting an optional WiFi USB adapter	1 x
RS485 for connecting a heat pump	1 x
CIB	1 x
TCL2	1 x
Micro SD memory card	1 x

Inputs & Outputs for Optional Accessories	
1x relay output	230 V/5A (K5)
3x relay output for the second heater	230 V/16A
3x PWM output	24 V DC (AO0, AO1, PWM3)
4x analog output	0–10 V (AO2–AO5)
1x input for Ripple control	230–400 V AC (HDO)
1x input for iPWM return signal from circulators	A/DI16
13x input for Pt1000 temperature sensors*)	measurement range –90 to 400 °C (A/DI0–A/DI13 and A/DI20)

*) The inputs can be also used as binary potential-free inputs for connecting e.g. immediate recirculation switch or a HRV boost switch etc.

Hot water heating from 10 °C to 45 °C with heating water inlet temperature of 60 °C	
Heat exchanger output	24 kW (600 l/h)

**Pressure drop diagram of RegulusHBOX K unit
– to heating system**

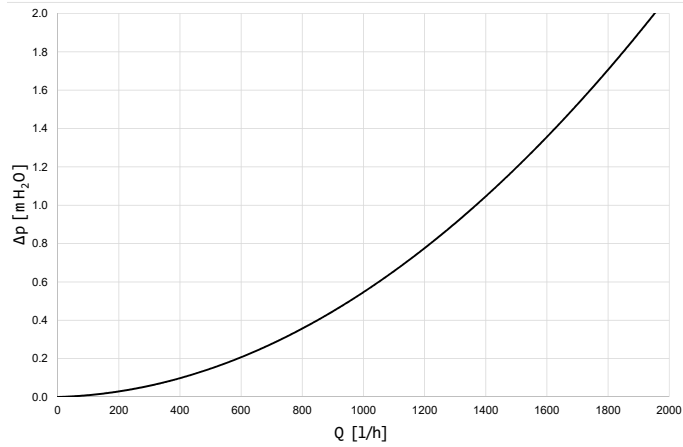

**Pressure drop diagram of RegulusHBOX K unit
– DHW heating**

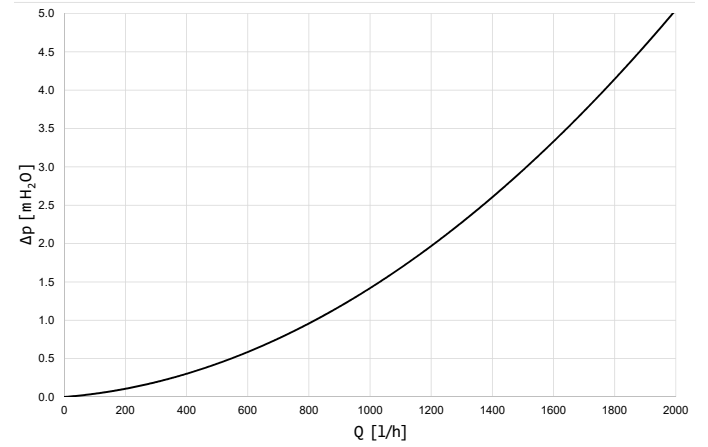

Performance curves for Wilo Para 25/8 iPWM1 pump of the heat pump

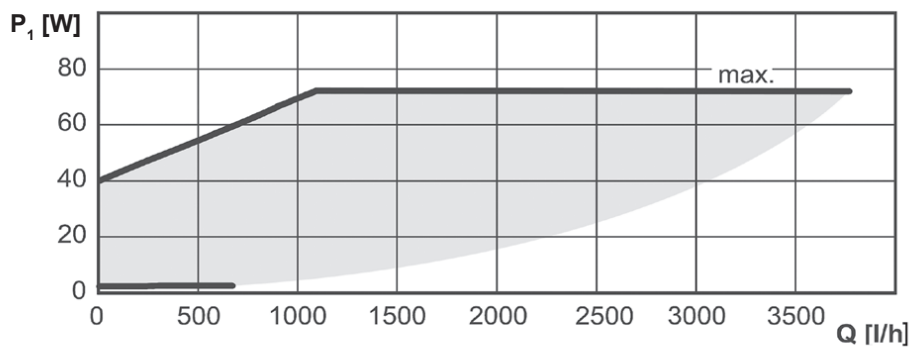
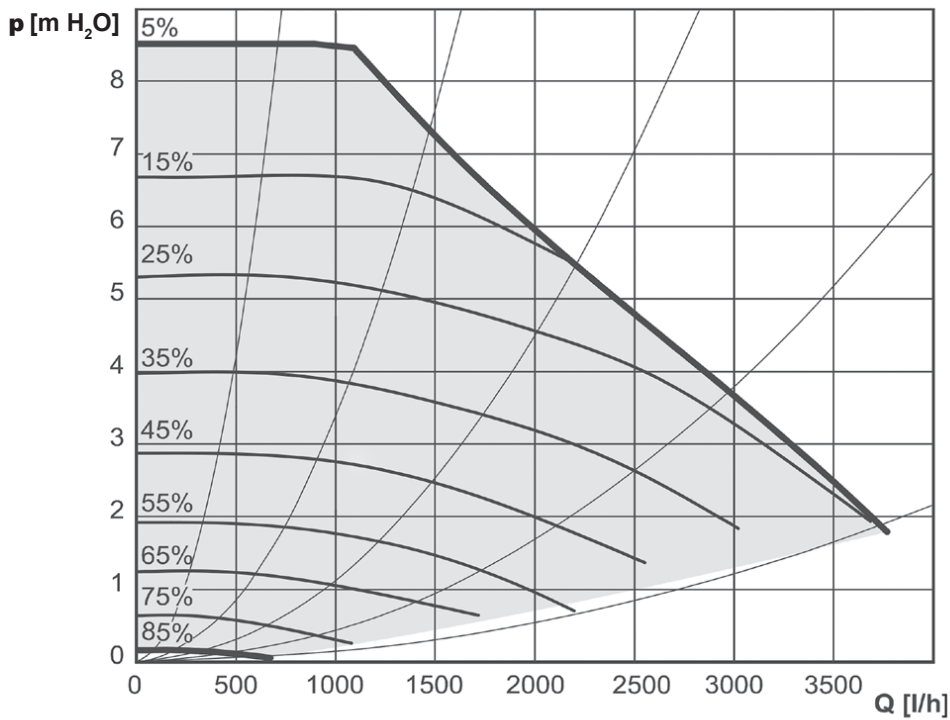

% - PWM signal

B. INSTALLATION, CONNECTION

B1. Dimensions

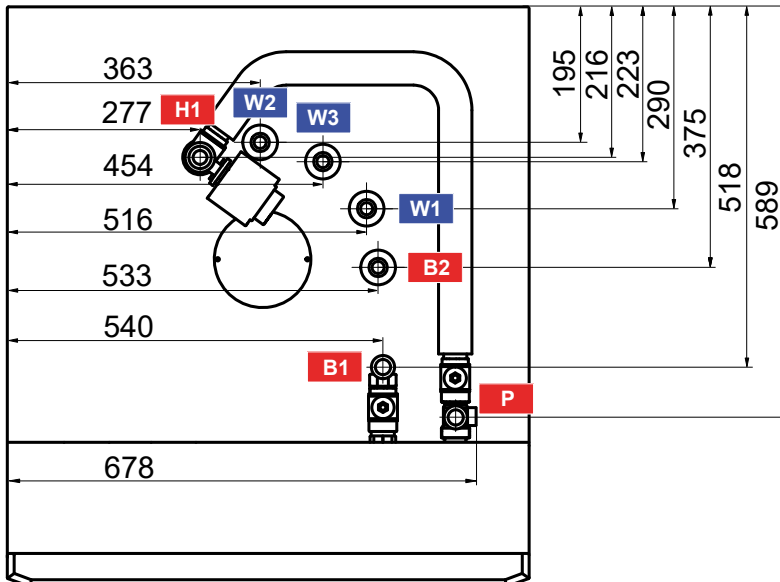
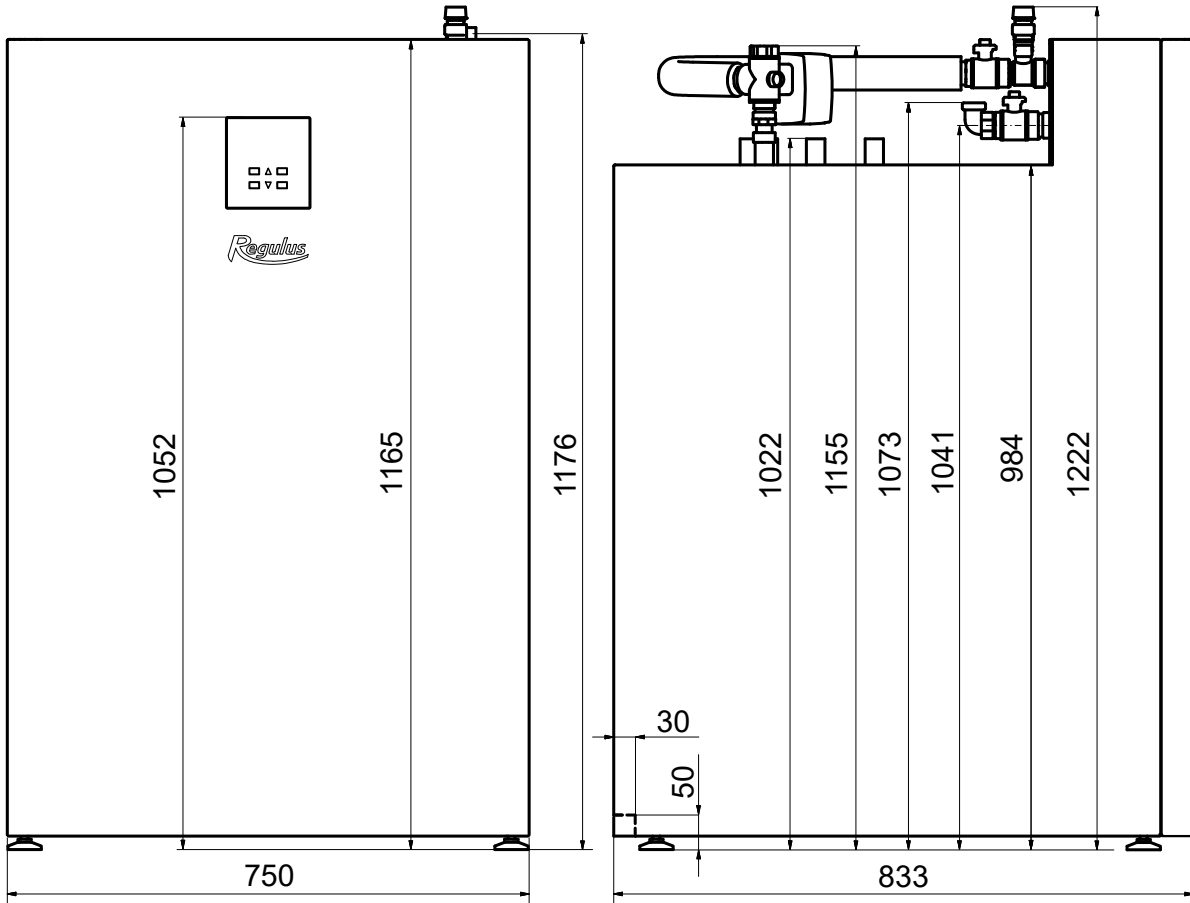

Pos.	Description	Connection	Height [mm]
W1	Cold water	G 3/4" M	1022
W2	Hot water	G 3/4" M	1022
W3	Recirculation	G 3/4" M	1022
B1	Incoming from heat pump	G 1" M	1073
B2	Return to heat pump	G 3/4" M	1022
H1	Flow to heating system	G 1" M	1155
P	Safety valve - heating s.	G 3/4" F	1176

B2. Installation Site Requirements

- RegulusHBOX K shall be installed indoors only.
- Ensure that no water can enter RegulusHBOX K at the installation site.
- Do not install the device in areas with a bath or shower in zones 0, 1 and 2.
- Do not install RegulusHBOX K at places with a risk of freezing.
- Do not install the device near aggressive, explosive or flammable gases, objects or substances.
- Observe the minimum required clearances from the constructions according to the picture.

Installation of RegulusHBOX K unit

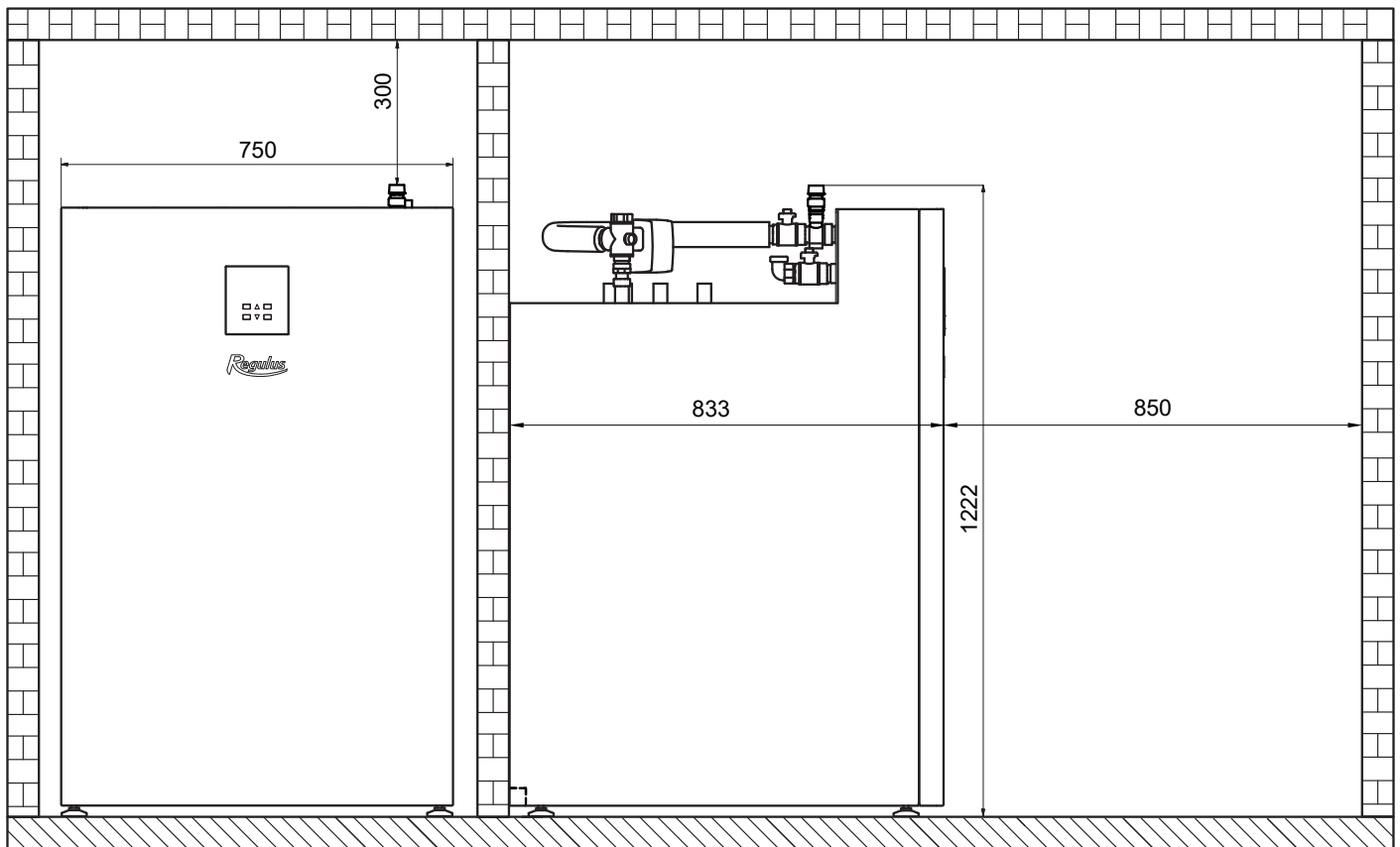

B3. Installation

Transport RegulusHBOX K to the installation site in a vertical position. **It is not permitted to transport RegulusHBOX K in a horizontal position.**





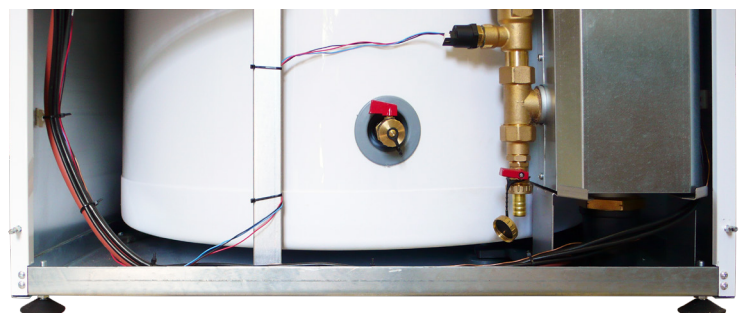

Install RegulusHBOX K on a level floor with sufficient floor loading capacity - the weight of RegulusHBOX K without heating water is 166 kg, with water it is 350 kg.

Level RegulusHBOX K vertically using its adjustable feet.



B4. Hydraulic Connection

A. The pipe connection outlets are marked with the respective pictograms on the upper side of RegulushBOX K.

- 1 - G 1" M flow to heating system 
- 2 - G 1" M incoming from heat pump 
- 3 - G 1" M return to heat pump 
- 4 - G 3/4" M hot water 
- 5 - G 3/4" M cold water 
- 6 - G 3/4" M hot water recirculation 

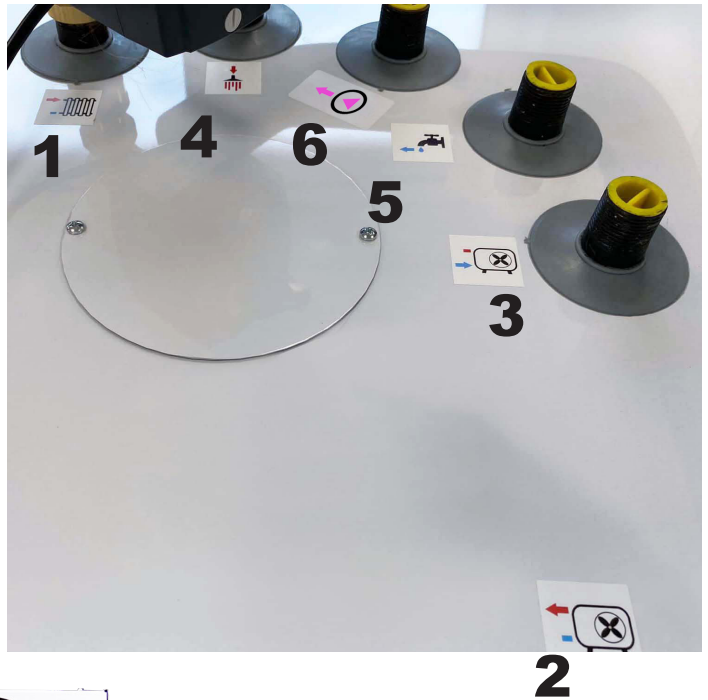

Safety valve PV-UT (see the hydraulic diagram of the internal connection) G 1/2" M x 3/4" F - supplied separately, attached to the T-piece intended for its installation - see the pic.

B. Connection to system

Connect RegulushBOX K to the system according to the hydraulic connection diagram:

- fit a safety valve PV-UT in the G 1/2" F neck of the T-piece

Warning: The plastic plugs placed in the connection sockets serve only as protection against damage during transport. All plugs must be removed before installation!

The control handle of the ball valves is located inside the RegulushBOX K unit, see Chap. A3. Components. Operation of these valves is reserved for service technicians only.

B4.1 Hydraulic Variant with one heating circuit

KEY

- 1 – Regulux heat pump (RTC, CTC)
- 2 – HBOX K indoor unit (RTC, CTC)
- 3 – heating system expansion vessel
- 4 – DHW expansion vessel
- 5 – safety kit for HW storage tank
- 6 – pump station for DHW recirculation – CSE TV ZV (optional)

- SV – cold water
- TV – hot water
- CV – hot water recirculation
- ÚT – central heating (heating system)
- KK – ball valve
- ZV – check valve
- REDV – pressure reducing valve (optional)
- VK – drain valve
- SVE – expansion vessel service valve
- MFB – Magnet Filterball

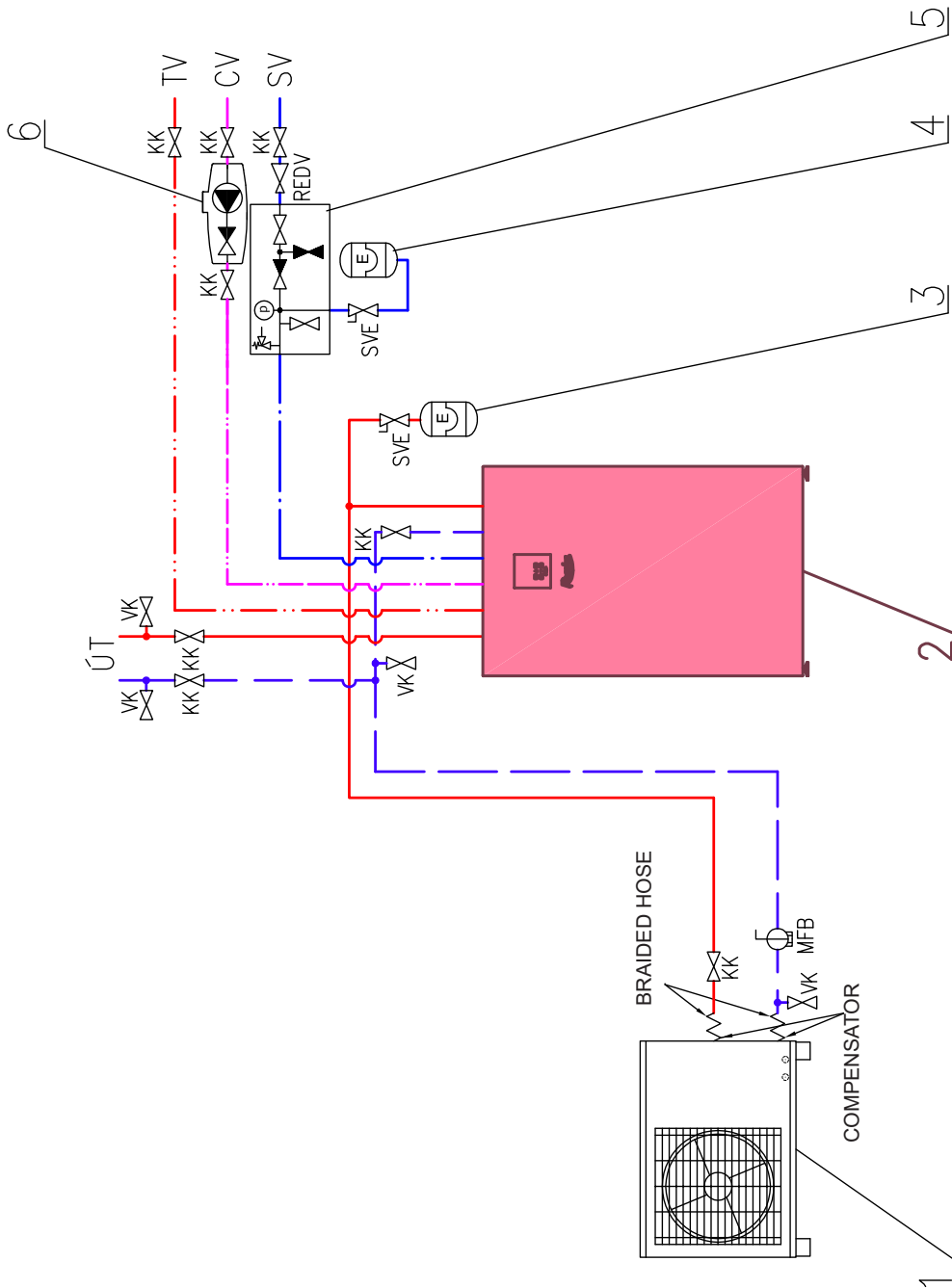

B5. Electrical Wiring

B5.1. Cable Entry

For the electrical connection of the RegulushBOX K, it is necessary to remove the front cover and the wiring cover located behind it.

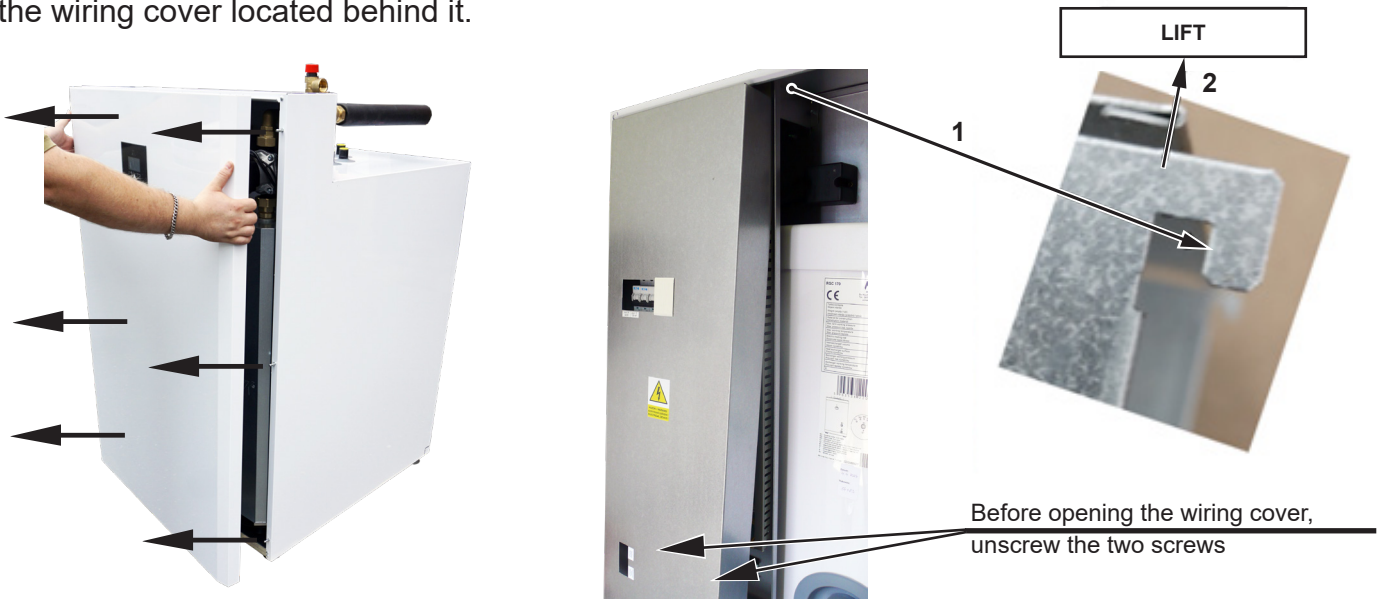

Two passages under the lid of the RegulushBOX K are used to connect cables

Note: The power supply cable is used not only to supply RegulushBOX K, but also to supply the heat pump!

We do not recommend the use of wire ferrules when connecting the maximum cross-section of the stranded wire to the connection terminal block. Wire ferrules are suitable for wires with a smaller cross-section (typically sensors, PWM, etc.). Minimum stripping length 9 mm.

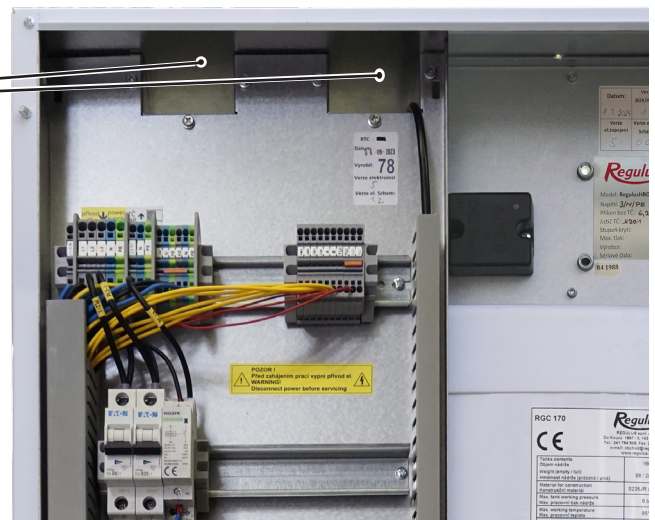

After closing the wiring cover, it is necessary to connect the control unit connector before refitting the front cover.



B5.2. Terminal Block

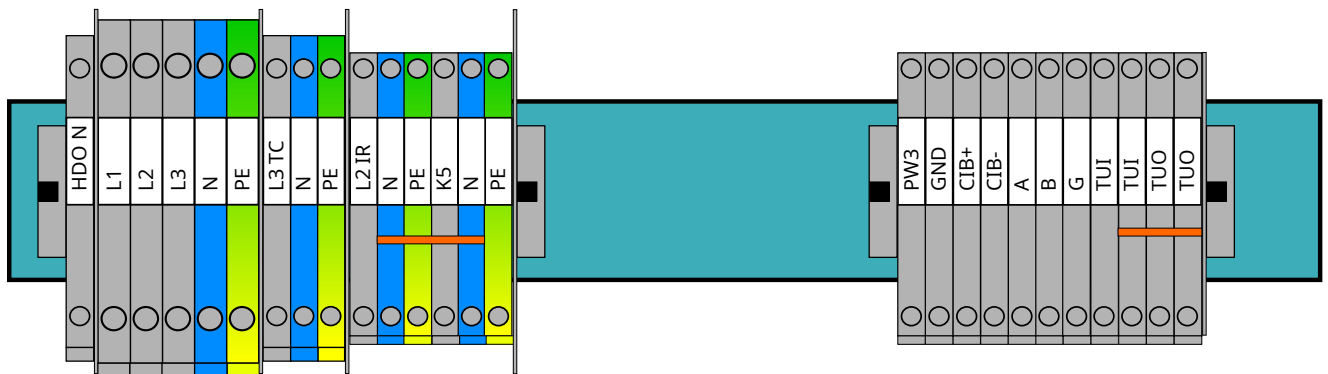

	4	6	4	2,5	max. mm ²
	2,5	4	2,5	1,5	max. mm ²

Universal output K5 have no default function. The devices switched from this output need to be set on the service level of the controller.

Connecting the outdoor sensor

Remove the outdoor sensor from the transport position in the RegulushBOX K unit (see the pic.) and connect it with the JYTY 4Dx1 cable to the A/DI0 terminal of the control board of IR RegulushBOX K - see the Wiring Diagram of M&R Peripherals.

B5.3. Complete Inner Wiring Diagram

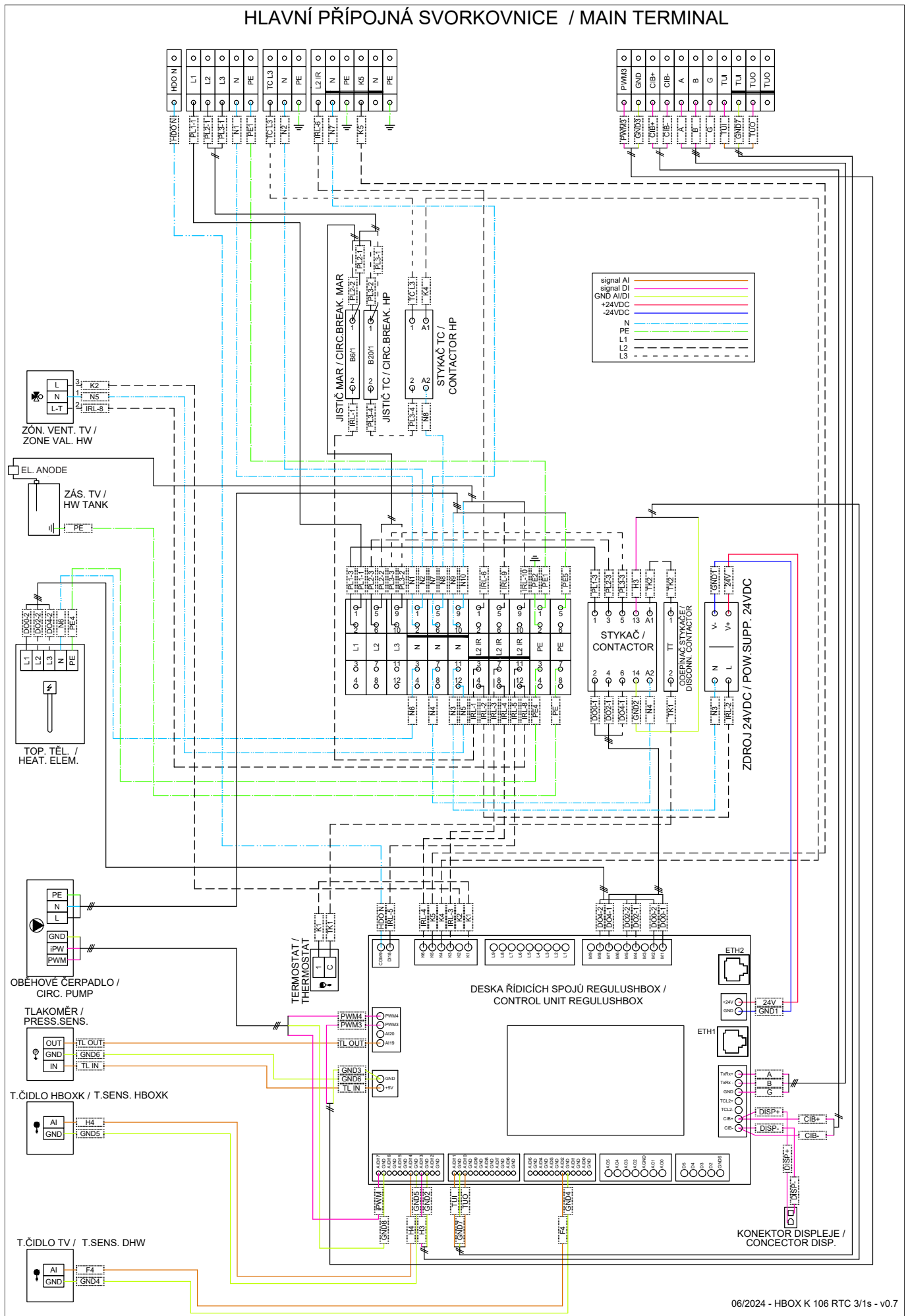

B5.4. Wiring Diagram of M&R Peripherals to RegulushBOX K

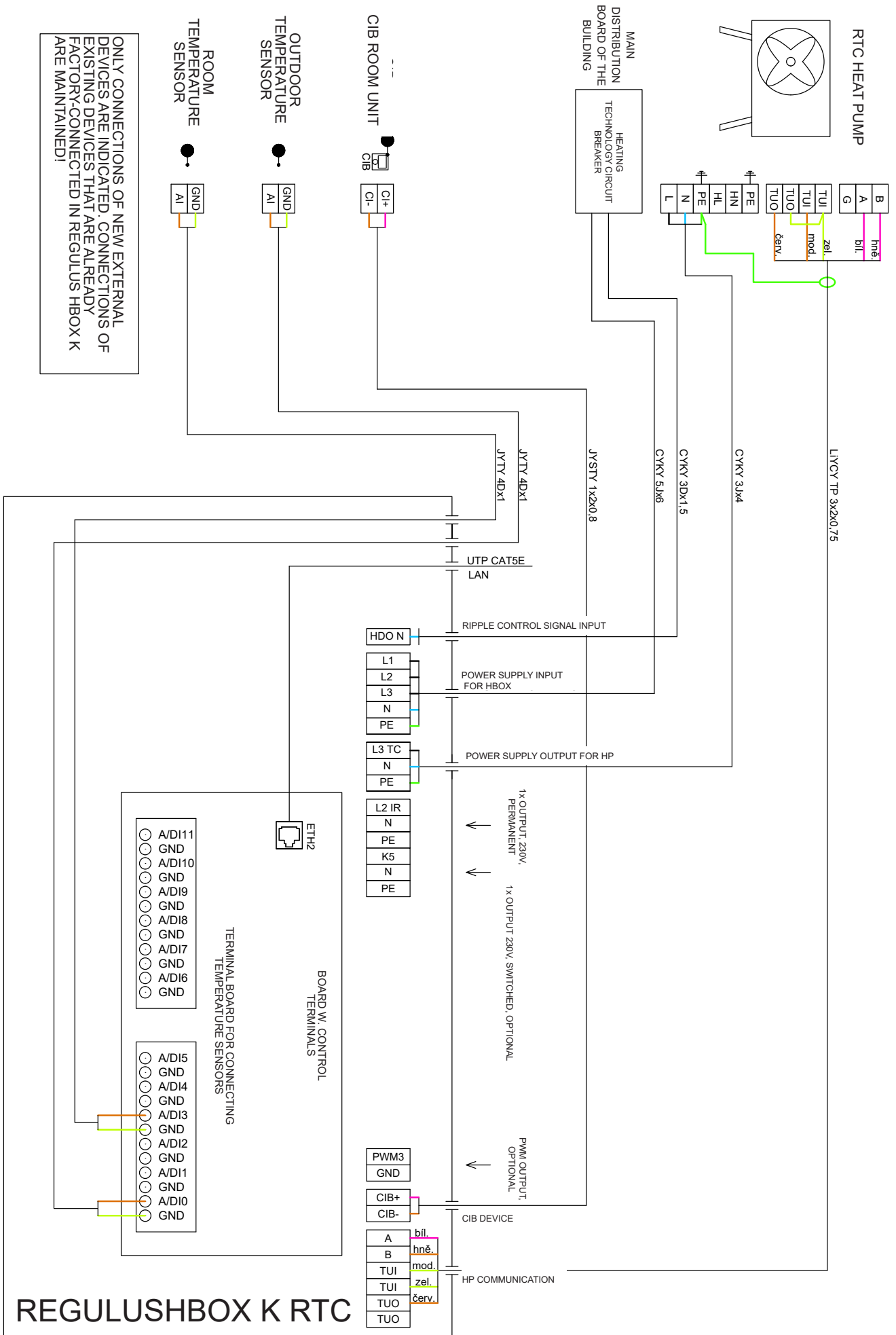

ONLY CONNECTIONS OF NEW EXTERNAL DEVICES ARE INDICATED. CONNECTIONS OF EXISTING DEVICES THAT ARE ALREADY FACTORY-CONNECTED IN REGULUS HBOX K ARE MAINTAINED!

REGULUSHBOX K RTC

B5.5. Connection and Adjustment of Optional Accessories - room sensor/unit, thermostat

In each heating zone, it is possible to measure the room temperature using one of the following elements:

- Pt1000 room sensor
- RC25 room unit
- RCA room unit (built-in display that is included in supply)
- WiFi RSW 30 Wireless room sensor
- current room thermostat with NO or NC contacts

Assign the type of room sensor (unit) installed to the appropriate zone in the service menu of the controller.

The web interface of the controller enables to assign a sensor or a room unit to each zone and set the influence of the room temperature on the temperature control in the zone. This option is not available on the display.

Pt1000 room sensor

This sensor connects to input AI3 in zone 1. Sensors in zones 2 to 6 can be connected via an additional module.

RC25 room unit

The RC25 room unit is used to sense the room temperature and relative humidity in the heated zone, easily adjust the required temperature using a knob and indicate the operating status and alarm. Refer to the RC25 manual for more information on optional functions.

Two-wire cables are used to install the CIB bus. We recommend using a cable with a twisted shielded pair and a core diameter of preferably 0.8 mm, e.g. J-Y (St) Y 1x2x0.8.

Units for zones 1 to 3 connect directly to the IR controller. Units for zones 4 to 6 require the installation of an external CIB master CF-2141 which connects to the IR controller via an Ethernet interface.

WiFi RSW 30 Wireless room sensor

The wireless room sensor is designed to sense room temperature and humidity in a heated zone. The sensor and controller shall be connected to the same network.

Thermostat

The thermostat in zone 1 can be connected to terminals AI4-AI11.

In zone 2 then via additional modules.

B6. Pre-commissioning Inspection

Before commissioning the device, make sure that:

- the heating system has been properly flushed and filled with clean and treated water
- the installation site requirements specified in chapter B.2 of this manual have been respected
- all protective covers are fitted and secured
- the shut-off valves of the hydraulic circuits are open and that the water flow through the unit is not blocked
- the inlet and outlet pipes to the unit are not interchanged
- the system is properly air vented and pressurized (usually to 1-2 bar) and the vent valve was closed after use
- air pressure in the heating system expansion vessel is by circa 0.2 bar lower than heating system pressure
- there is no water leakage
- the electrical installation is carried out in accordance with the applicable regulations and with the label on the unit (check in particular the size of the power cable, circuit breaker and the correct earthing connection)
- the right mains voltage is present at the installation site
- the insulation of the cables is not damaged and that they are properly tight in the connectors on the pump
- power and control cables of the heat pump's circulation pump are properly connected to connectors on the pump
- the accessories are connected properly
- all documentation for the installed device is available

Only after checking the above points can the circuit breaker of the RegulushBOX K unit be switched on and the device commissioned.

Note: Commissioning may only be carried out by a person trained by the manufacturer and professionally qualified.

C. SETTINGS USING THE MAIN DISPLAY

A control panel designed for user system settings is located on the front cover.



The panel consists of a display and six control buttons:

- **ESC** to return to the previous screen.
- **ENTER** to select and save a value
- **ENTER** to select and save a value
- **Two auxiliary buttons with variable function indicated on the display.**

C1. Main menu

The home screen of the controller shows the date, time and temperatures. You can return to the home screen at any time by pressing the help button with the house symbol .

You can scroll through the main menu from the home screen using the down arrow key .

Home screen:

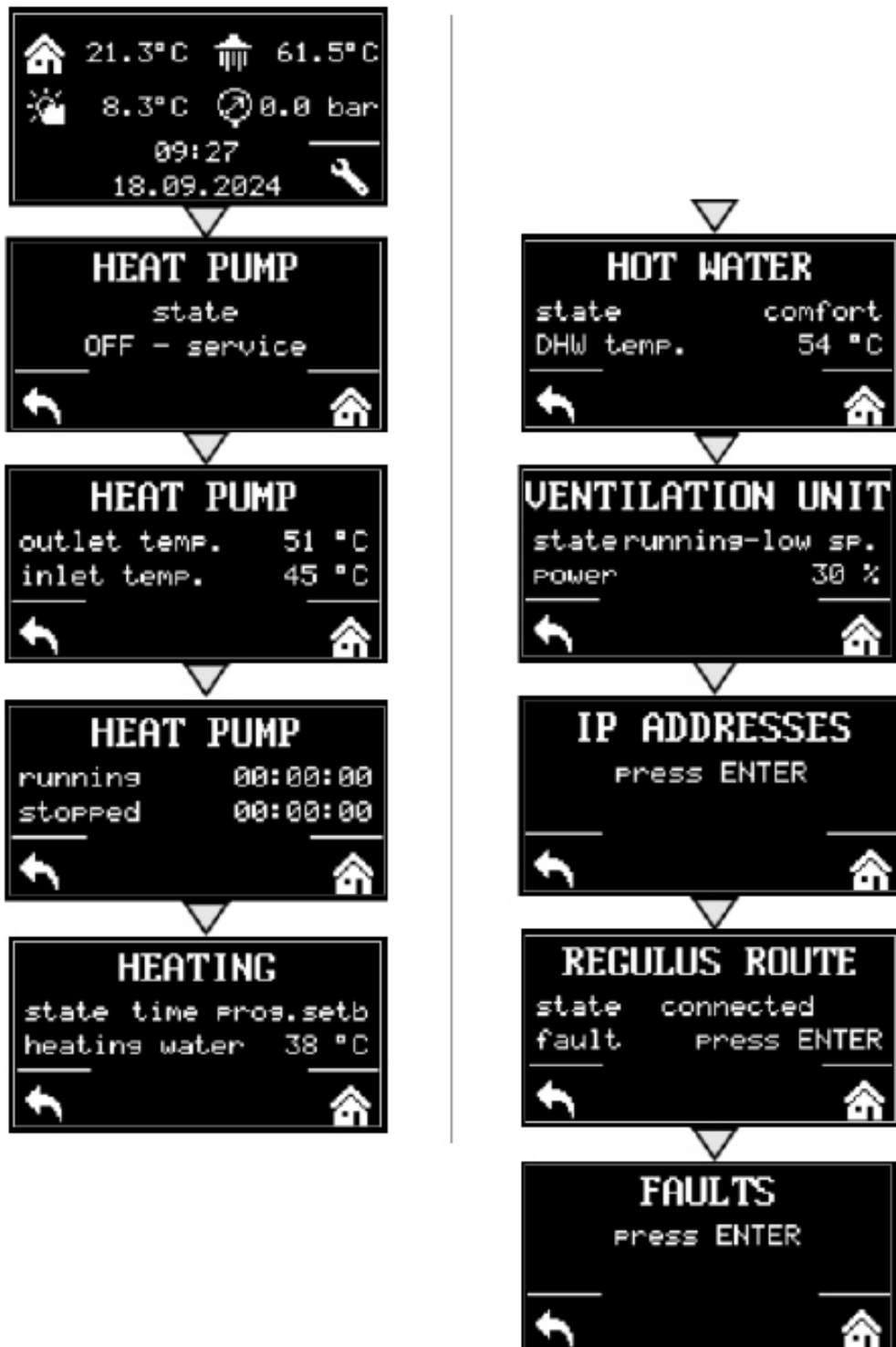

C1.1. Settings for HEATING

To access the HEATING menu from the home screen, press the SETTINGS button .

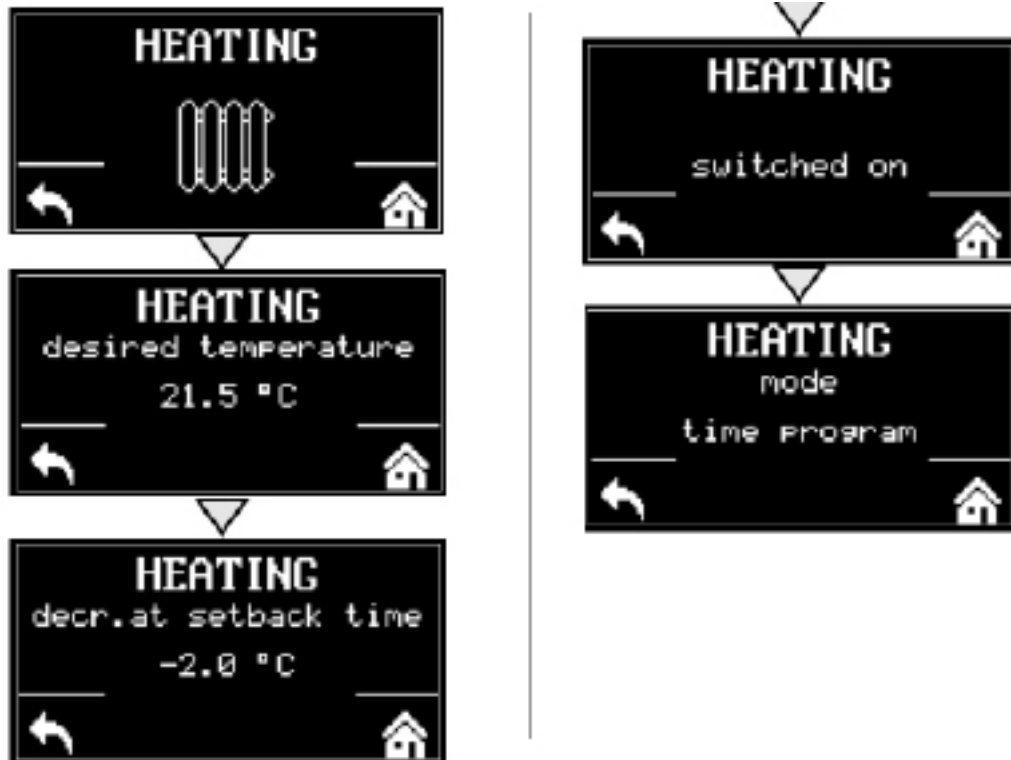

C1.2. Settings for HOT WATER

You can access the HOT WATER menu from the home screen by pressing the SETTINGS button  and then pressing the down arrow button once.

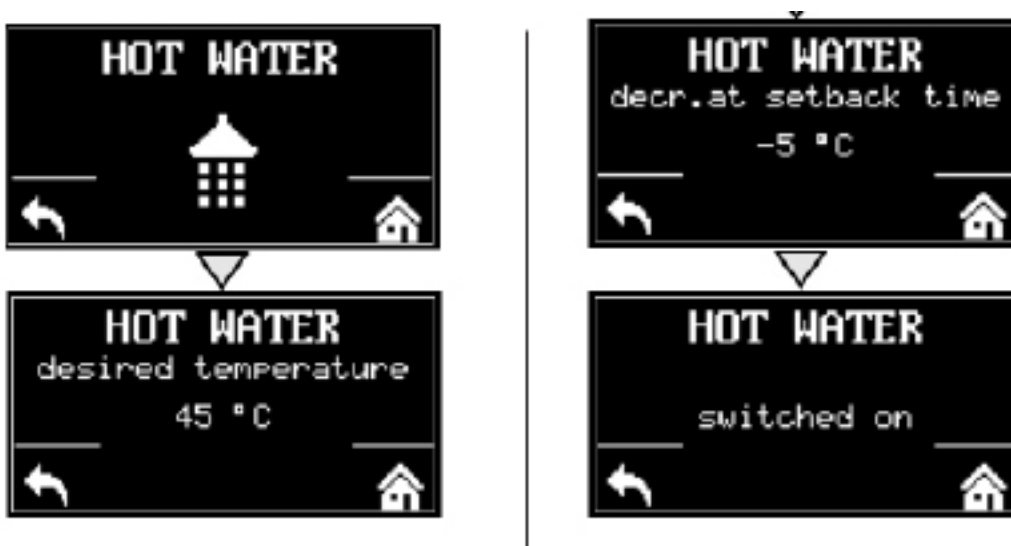

C1.3. Settings for DHW RECIRCULATION

To access the DHW RECIRCULATION menu from the home screen, press the SETUP button  and then press the down arrow button twice.

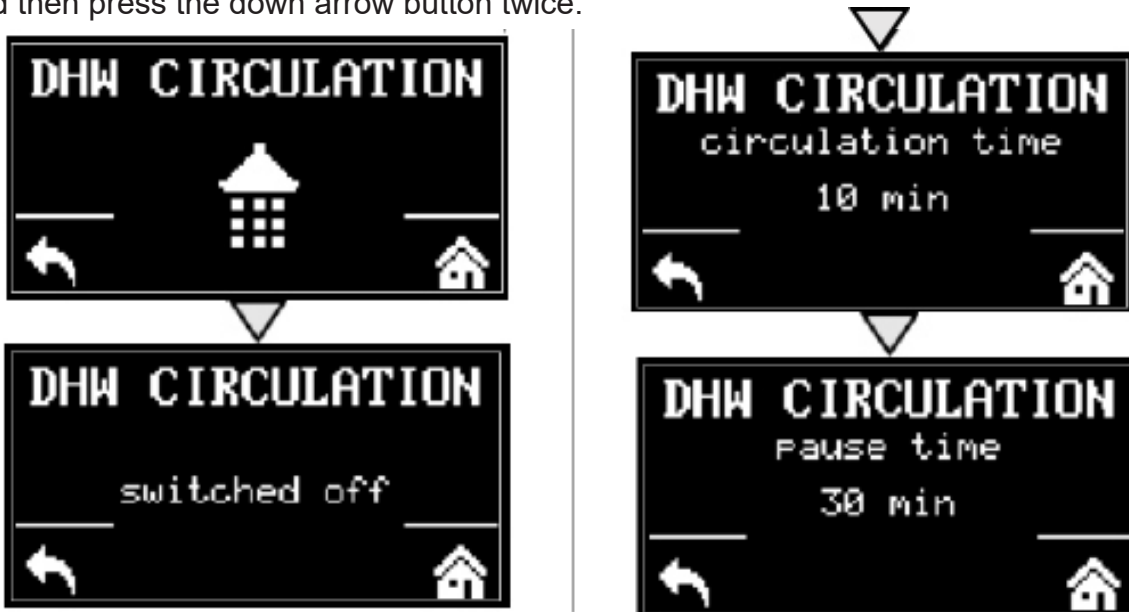

C1.4. Settings for HEAT PUMP

To access the HEAT PUMP menu from the home screen, press the SETUP button  and then press the down arrow button three times.



You can switch the heat pump on or off.

C.1.5 Settings for AUX. SOURCE

To access the AUX. SOURCE menu from the home screen, press the SETUP button  and then press the down arrow button four times.



You can switch the heat pump on or off.

C.1.6 Settings for VENTILATION

To access the VENTILATION menu from the home screen, press the SETUP button  and then press the down arrow button five times.





You can switch the ventilation on or off.

C.1.7 Settings for REGULUS ROUTE

To access the VENTILATION menu from the home screen, press the SETUP button  and then press the down arrow button six times.



You can switch Regulus Route on or off.

D. HOW TO SET ACCESS TO CONTROLLER WEBSITE

The controller contains an integrated website showing an overview of the heating system and user settings. To reach web access to the controller's website it is necessary to connect the controller either to the local network or directly to the PC using a network cable. Alternatively, it is possible to use the IR Client mobile application.

D1. Access to the controller via local network

- first you need to find out the IP address of the controller, which was either automatically received from the router, or was set as fixed during commissioning
- on the controller, press the DISP button and the down arrow, the network settings will appear on the display
- write down the IP address from the controller display and insert it into the command line in the Internet browser (Internet Explorer, Firefox, Chrome,...) of your device that is connected to the same network, i.e. to the same router
- to restore the original display, press the DISP
- after entering the IP address in the web browser, the login form will be displayed

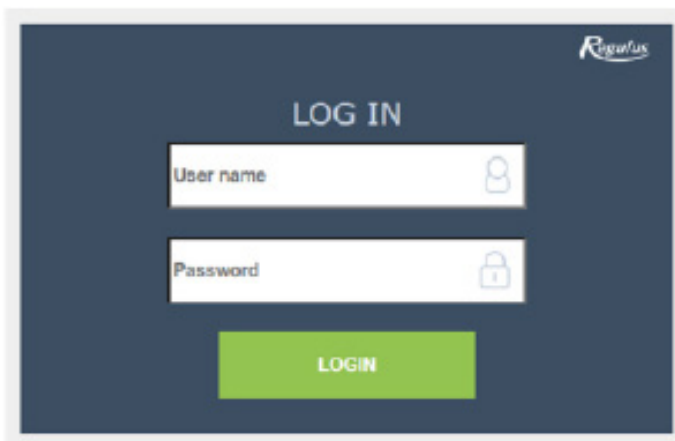

Fill in the username and password, then click the button



D2. Access to the controller directly via Ethernet cable

- if the device is not connected to the Internet, you can log into it directly via an Ethernet cable
- it is necessary to get the computer and the controller on the same network
- on the controller, press the DISP button and the down arrow, the network settings will appear on the display, look for the form of the IP address.
- on the computer, in the Internet connection section, find the center of network connections and sharing; if the controller is connected to the computer, the Ethernet or Ethernet 3 icon will be displayed here ...

Click the Ethernet icon, a status window will pop up:

Access type: Internet
Connections:  Ethernet 3

In the lower left corner, click on properties.

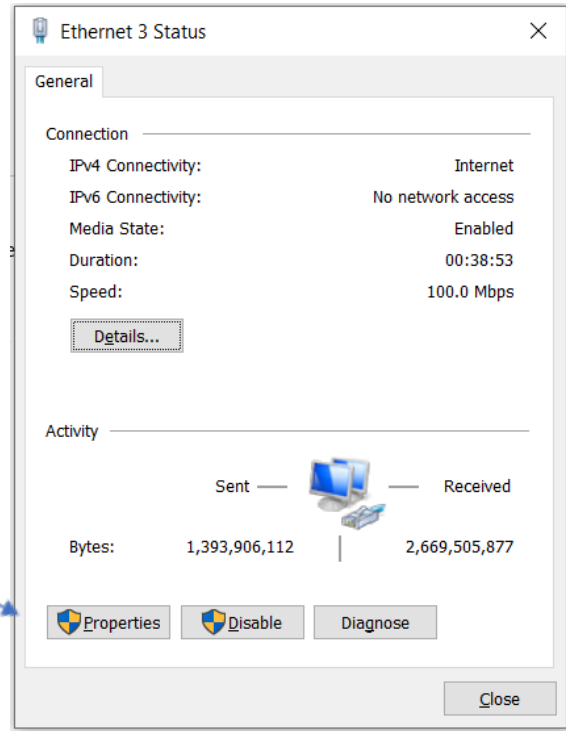

The network properties window will pop up.

Here you need to click with the left mouse button on the IP protocol version 4 so that the block turns blue

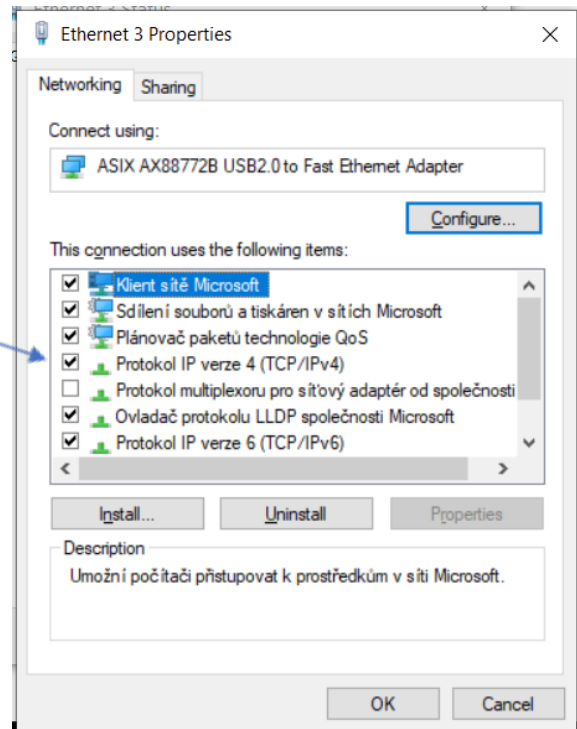
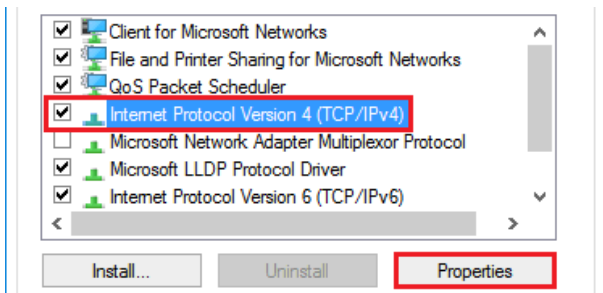

Click on properties again

A window will pop up where the IP address can be entered automatically or using Use the following IP address.

Select the box Use the following IP address and enter an IP address in the same network as the fixed IP address in the controller (**different final three digits must be used**) plus fill in the subnet mask*.

The form of the IP address depends on the type of control (needs to be found via the DISP button and the down arrow).

The fixed IP address of IR10 and IR12 is 192.168.100.14

The fixed IP address of IR14, BOX, HBOX and HBOX K is 192.168.14.14

The subnet mask is the same for all of them 255.255.255.0

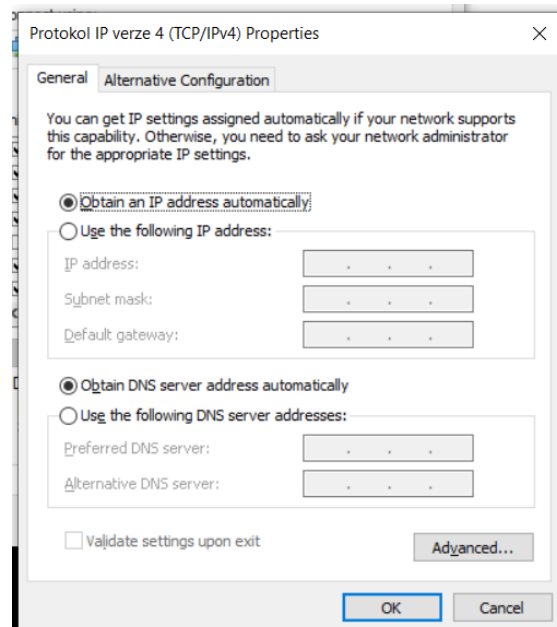
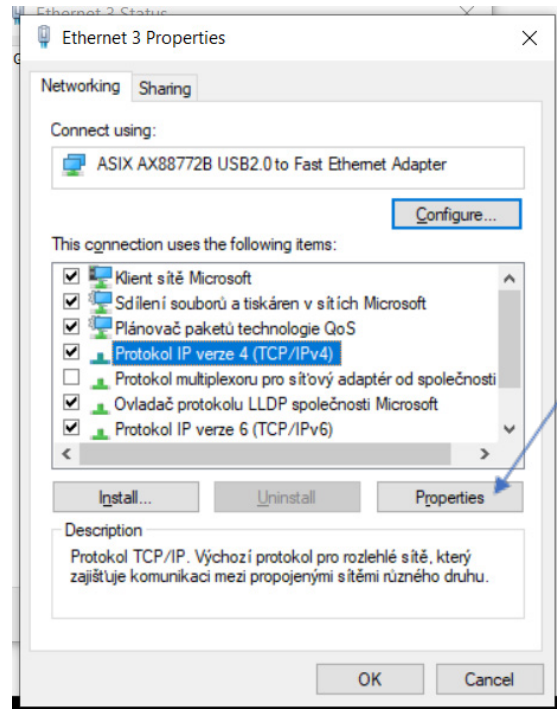

* If you already use the „Use the following IP address“ option, note down the values needed to return to the original setting before changing the settings. **The IP address must match the IP address found from the controller in the first three triple digits and must differ in the fourth triple digits.** In this case, the controller has the address 192.168.14.14 and the PC the address 192.168.14.15. The triple digit must be in the range 001-254. After filling in the IP address, press the tab key on the computer keyboard. This automatically fills in the subnet mask (255.255.255.0). It is not necessary to fill in other fields.

For example:

Then click on OK and close the remaining windows.

Enter the IP address of the controller into the web browser address bar.

And continue as in the case of connection in the local network.

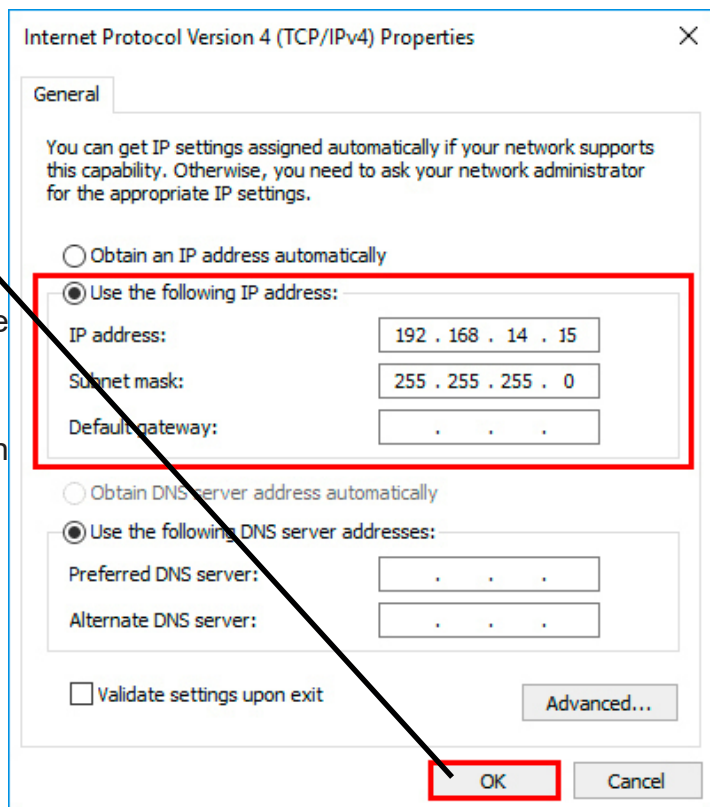

This connection setting is for a computer running Windows 10 or older. It will be different in Windows 11.

Entering the IP address of the controller into the web browser will take you to a login form from which you can visit the user or service level of the controller. Once the computer is disconnected from the controller, we recommend returning the network connection to its original state.

The username for the user level is: **user**,

The password for the user level is: **user**.

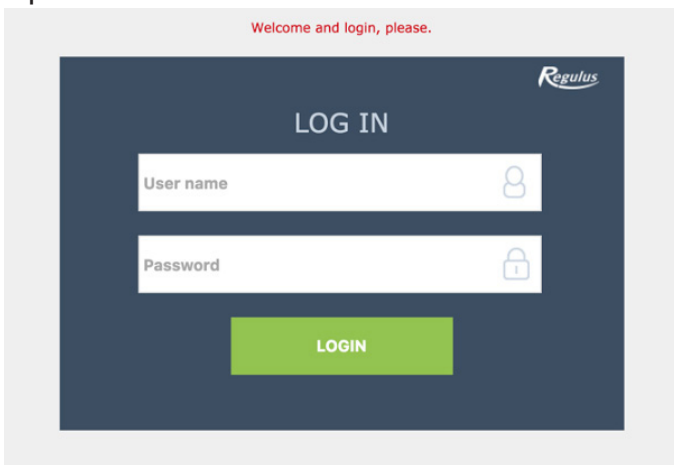

D3. Connection via IR Client mobile application

Regulus IR Client is free to download from **Google Play** (for Android) and **App Store** (for iOS).

After logging in to the IR controller via the web interface using the Regulus IR Client application or the RegulusRoute service, the basic screen with tiles is displayed.



Regulus IR Client

Regulus spol. s.r.o. Communication

Everyone

This app is available for your device

Add to Wishlist

Google Play (for Android)



App Store (for iOS)

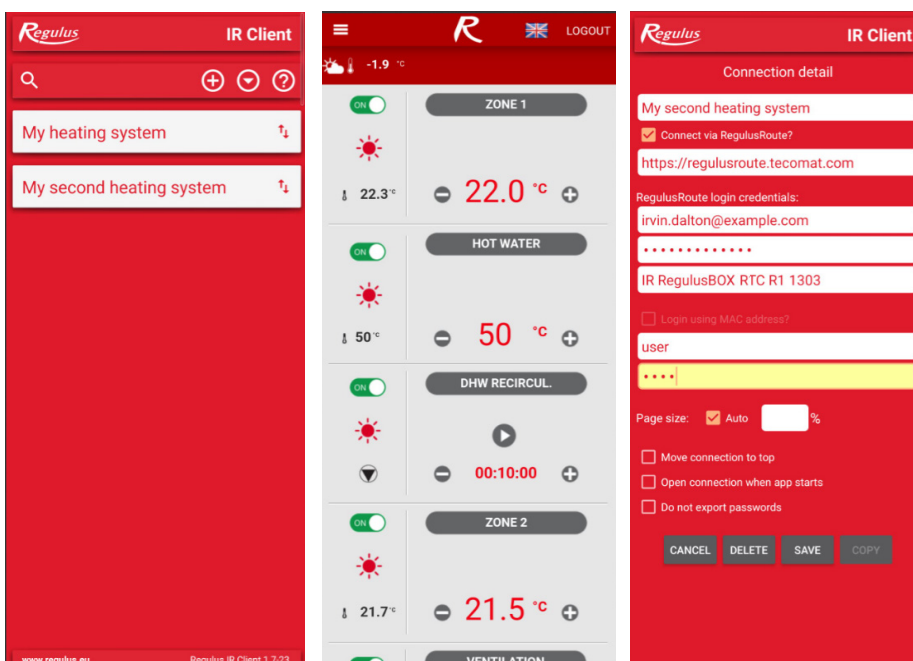

E. SETTING THE CONTROLLER THROUGH WEB BROWSER

E1. Home Screen (HOME)

The home screen contains basic information about the two heating zones, hot water heating, recirculation and ventilation zone.

Service-enabled zones are highlighted in color and can be controlled.

Service-deactivated zones are only shown and cannot be controlled.

Home page shown in your computer browser

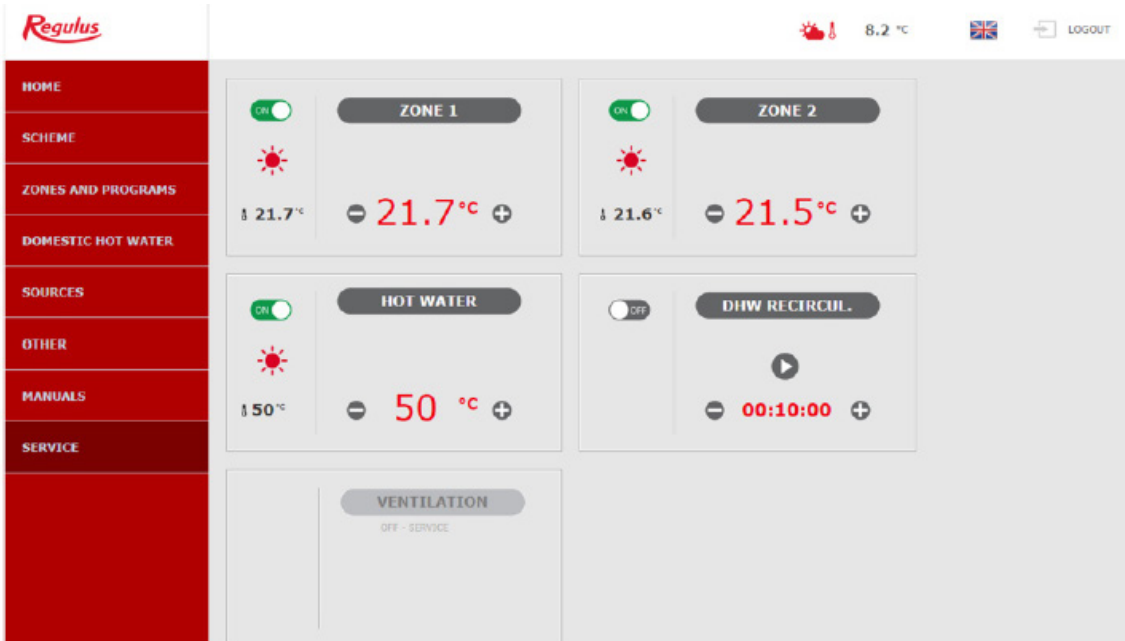

Home page shown in the Regulus IR Client mobile application

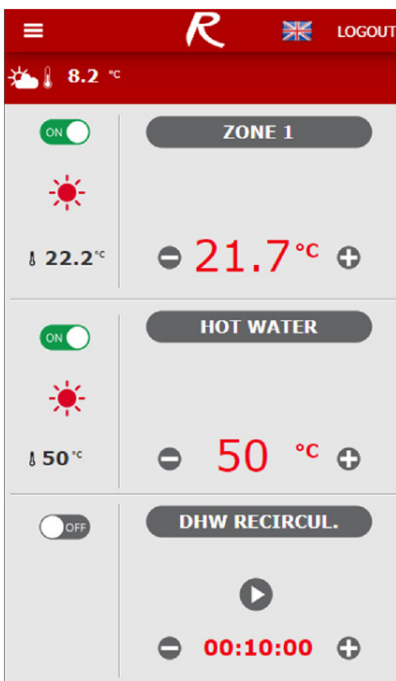

E2. Tiles for Heating and Hot Water

The ON/OFF button is used to turn the zone on or off on the user level.

Clicking on this button will open the detailed zone settings.

Sun-Moon (comfort-setback). The snowflake indicates active cooling. Information about the current zone mode.

Heating zones: current room temperature (if a room sensor is installed)
DHW zone: DHW temperature

Desired temperature. This temperature can be increased or decreased with the plus and minus buttons.

If the zone or DHW is in setback period, a moon symbol is shown here.

Click on the (i) button to change the desired temperature during a setback period.

During a setback period, the desired temperature reduced by the decrease value is shown on the tile.

During a setback period the desired temperature cannot be adjusted by the plus/minus buttons on the tile (they are hidden).



In some cases, warning triangles can appear in the DHW tile. You can find a more detailed description of their meaning in the DHW menu.

E3. Tiles for Hot Water Recirculation and Ventilation

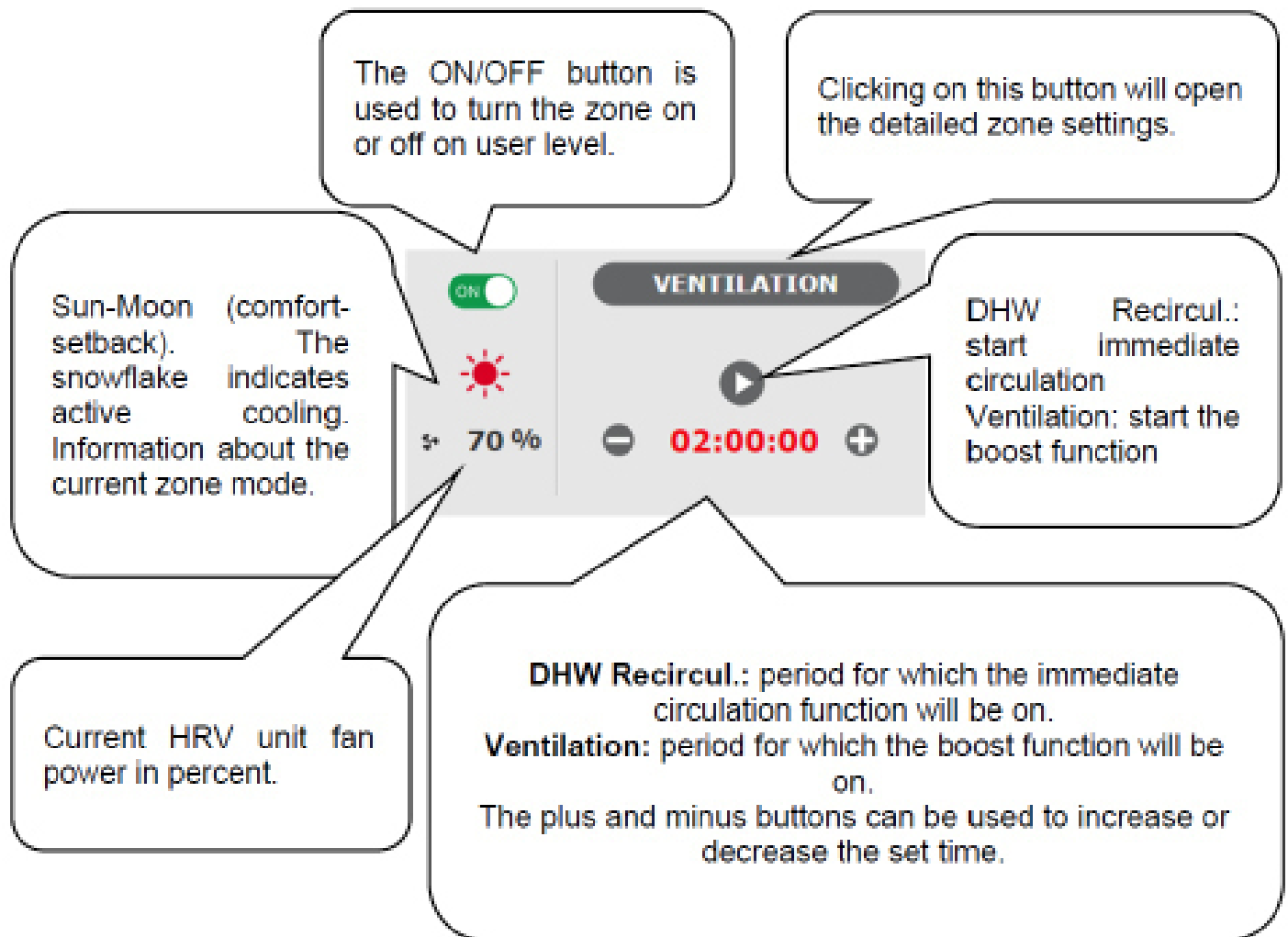

E4. Display of the Diagram (DIAGRAM)

Schematic representation of your hydraulic connection with a clear display of important quantities, states and information. The diagram should therefore always correspond to your current hydraulic connection.

For proper display in the mobile application, it is necessary to rotate the device for landscape view.

Display in the upper left corner

OUTDOOR TEMPERATURE - display of the current outdoor temperature

HC pressure - display of pressure in the heating system

RIPPLE CONTROL STATUS - when the controller is wired to the two-tariff electricity supply system, the current status will be displayed here according to the distributor rate (**HIGH / LOW**)

HOLIDAYS - here it is displayed whether or not the holiday function is active; this function makes it possible to adjust the heating temperature of the individual zones and DHW to a lower value during a longer stay outside the heated building, without changing the permanent setting in the individual zones. Holidays are controlled in the HEATING menu.

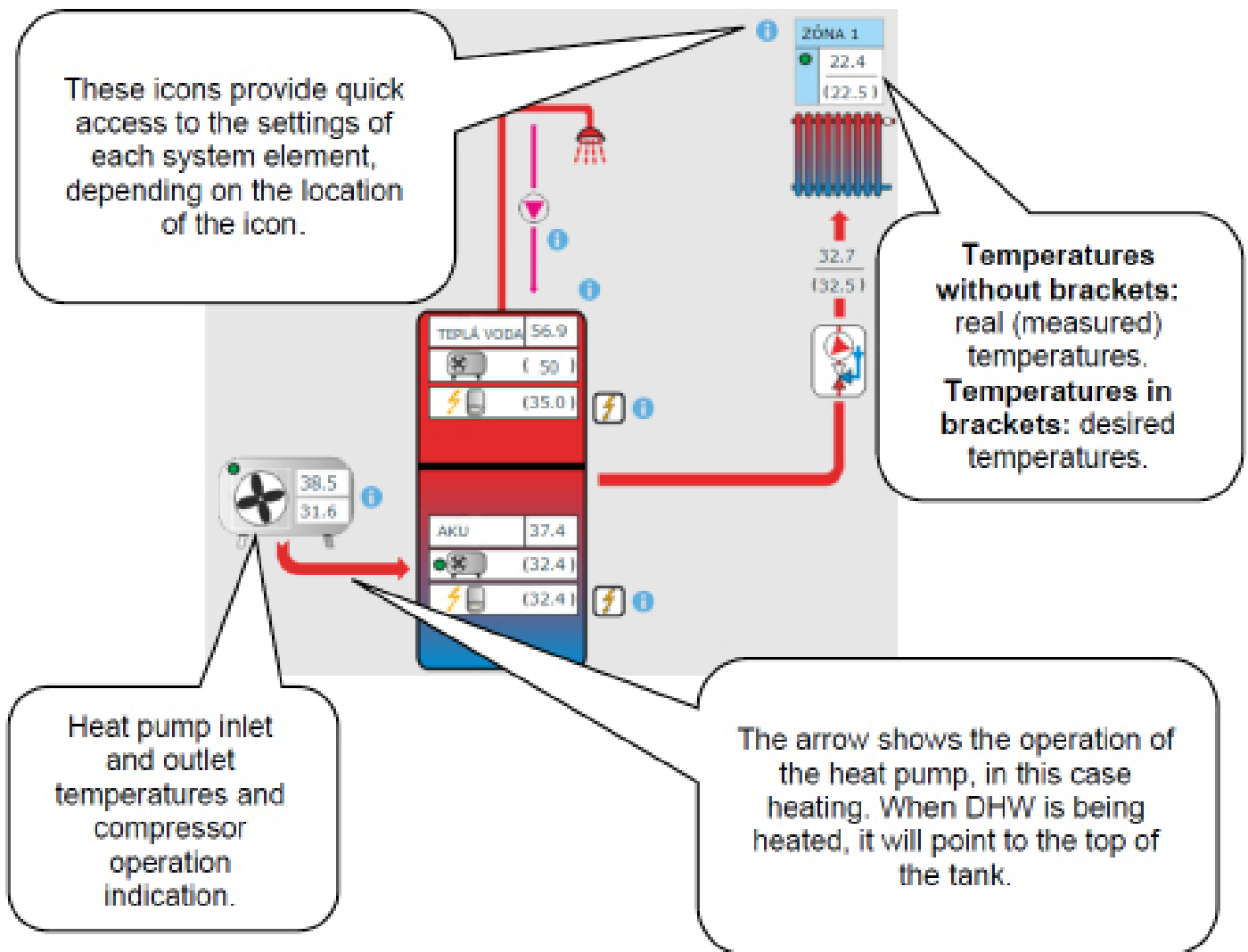

E5. Heating zone menu (HEATING)

The menu is used to select the settings of one of the heating zones (Zones 1 to 6), to set the thermal store heating (ThSt Zone) and holiday mode settings (Holidays), or to set the pool heating. (Pool heating - if pool heating is solved through the mixing pump station and bound to one heating zone. If pool heating is unmixed, the UNI function turns into pool function.)

E6. Heating Zone Settings (Zone 1 to 6)

The heating zone can be switched on or off by the user with the **ON/OFF** button. If the zone is switched off by the user, the circulation pump is switched off and the mixing valve shifts to the closed position.

The pump and valve can be switched on by the frost protection (if switched on and active).

The screenshot shows a heating control interface with the following data points and callout boxes:

UNIT STATE	HEATING	ROOM TEMPERATURE	21.8 °C	HEATING WATER TEMP.	29.7 °C
COMFORT TEMPERATURE CONTINUOUS		RELATIVE HUMIDITY	45.0 %	DESIRED TEMPERATURE	29.7 °C
		DESIRED TEMPERATURE	21.7 °C		

Callout boxes provide the following information:

- Display of the current status of the heating zone.
- If a room sensor is present, the current room temperature is displayed here, if a room unit is used, also the air humidity is shown.
- Current heating water temperature.
- Additional information on the heating zone status (e.g. information on mode...).
- Desired room temperature.
- Desired heating water temperature calculated from the OTC curve.

E6.1. Room temperature setting

Desired temperature (°C) - setting the desired room temperature in zone. The temperature can also be changed using plus and minus keys

Decrease during setback time (°C) - setting by how many °C the desired room temperature will be decreased during setback time; the decrease value can be changed using plus and minus keys.

The decrease value during setback temperature can only be set with the time program switched on.

In terms of optimal heat pump operation, a maximum decrease of 2°C is recommended. (This is a maximum value in the factory setting, it can be changed on the service level.)

Comfort mode is automatically activated when the outside temperature drops below -2 °C. This function is designed to save energy so that it does not switch on an auxiliary (bivalent) source in the event of a sudden request for a higher zone temperature. This function can be switched off on the service level.

If a RC 25 room unit is connected in the given zone, permitting to change (correct) the desired temperature using the rotating knob, correction is shown in the room temperature menu.

E6.2. Time program settings

Depending on the type of heating system selected on the service level, the possibility of using a time program is automatically adjusted.

When underfloor heating is selected, the factory time program is switched off. One time program can be enabled on the service level. (We do not recommend using a time program due to the great thermal inertia of floor heating.)

When choosing radiators or fan coils, the factory time program is enabled. It is also possible to use a second period, or to switch off the time program.

If the time program is switched off, the heating zone follows the set desired temperature.

Use time program - setting the time period during which the zone will heat to the desired room temperature. Outside the time period, the desired room temperature will be reduced by the decrease value.

Use second period - setting the second time period during which the zone will heat to the desired room temperature. Pre-set time periods can be easily overwritten.

The following buttons are meant to copy easily the set values to further days: **COPY Mo TO Mo-Fr, Mo-Su and COPY Sa TO Sa-Su.**

Zone off during setback ... This permits to switch off the heating zone completely in setback mode. The circulation pump stops and the mixing valve closes. (This function is switched off on the service level in the factory setting, it is not suitable for all installations, and a service technician must be contacted to activate it.)

E6.3. Winter / Summer function settings (blocks heating in summer)

When activating **HEATING BLOCKED IN SET PERIOD**, set the date of the beginning and end of the period when heating will be always blocked, disregarded of the current outdoor temperature (overriding heating block by the outdoor temperature).

When activating **HEATING BLOCKED BY OUTDOOR TEMPER.**, set the time intervals for the pre-set outdoor temperatures after which the heating will be blocked (summer mode will be enabled) and the heating will be unblocked (winter mode will be enabled).

Another condition for automatic mode switching is reaching the required indoor temperature. This means that if the indoor temperature is lower than required, then there will be no automatic switch to summer mode. Similarly, there is no automatic switch to winter mode if the indoor temperature is higher than required

In winter mode, zone heating is switched on (the zone is heated to the required temperature according to the current comfort/setback mode). In summer mode, zone heating is switched off.

E6.4. OTC curve settings

The purpose of weather compensating control is to reduce the heating water temperature when the outdoor temperature rises (and vice versa). This can effectively reduce overheating or underheating of dwelling space and also increase the efficiency of system operation. From the point of view of energy savings and thermal comfort in living rooms, it is more advantageous to heat the building to the required room temperature with a lower heating water temperature for a longer time than with a higher heating water temperature for a shorter time.

The basic parameters of the OTC curve, the maximum and minimum temperatures for the zone are set by the service technician during commissioning at the service level.

The resulting calculated OTC temperature is automatically adjusted according to changes in the desired room temperature. (If a room sensor is installed, the calculated OTC temperature is also affected by the value at the given sensor.)

OTC curve menu is intended only for minor adjustments in case of zone overheating or underheating. Bigger changes are better made on the service level.

The OTC curve is displayed in a simplified menu in the factory settings of the controller, with the current outdoor temperature and the calculated current OTC temperature displayed. The current OTC temperature (currently desired heating water temperature) can be adjusted with the plus and minus buttons.

Make the changes in small steps only, 2-3°C max., and wait for a longer time (recommended: 1 day) too see how the changes take effect.

Remember that in the simplified menu, the part of OTC curve is modified that is related to the current outdoor temperature.

In order to set the entire OTC curve, expert settings are needed.

Expert settings are intended for more experienced users, there are two pairs of plus and minus buttons.

One for temperatures above zero and the other for temperatures below the freezing point. By clicking on the individual buttons, the heating curve is reset mainly in the values corresponding to the location of the buttons.

NEW TEMPERATURE - displays the temperatures adjusted with the buttons at the current outdoor temperature

SAVE CHANGES - confirms the changes made and saves them to the controller's memory

CANCEL CHANGES - returns values, cancelling current adjustments

RESTORE FACTORY SETTINGS - restores the factory settings of the heating curve

The expert settings are fully linked to the basic settings of the heating curve and all changes are reflected in the zone setting.

Note: When setting the OTC curve in the mobile application, it is necessary to rotate the device to landscape view. (In portrait view this item might be not visible on the display.)

E6.5. Cooling settings

The cooling function is disabled on the service level in the factory setting (hidden for the user).

For cooling, the limitations listed in chap. A2.2 apply.

With the ON/OFF button, it is possible for the user to turn on the cooling and set the desired room temperature (it corresponds to the comfort temperature for heating).

Cooling above outdoor temperature means that cooling is active only when the outdoor temperature exceeds the set limit (Outdoor temperature of transition).

E7. ThSt Zone

The zone of thermal store heating to the set temperature according to the time program. The zone can be switched on or off by the user with the **ON/OFF** button.

This function is mainly used when there is an increased heat demand outside the heating season or to store more heat than is needed for heating. An example would be a swimming pool in combination with underfloor heating.

Desired temperature (°C) - setting of the desired heating water temperature in the thermal store. The temperature can also be changed using plus and minus keys.

Decrease during setback time (°C) - setting by how many °C the desired heating water temperature in the thermal store will be decreased during setback time. The decrease value can be changed using plus and minus keys.

The time program settings are identical to the time program settings in zones 1 - 6. The actual required thermal store temperature is then calculated as the maximum of the requirements from the thermal store zone and the active heating zones.

E8. Pool Heating

This pool heating function is available only if pool heating is solved through the mixing pump station and bound to one heating zone. If pool heating is unmixed, the UNI function (E.12.8) turns into pool function.

Pool heating can be switched on or off by the user with the **ON/OFF** button.

Desired temperature (°C) - setting of the desired pool temperature.

The menu shows the temperature in the pool, the source temperature and information on whether the heating is active or inactive.

Thermostat – the switch-on and switch-off difference for pool heating control is shown here.

Request for heat source - with the ON/OFF button, you can choose whether the heating source will be used to heat the pool. When the demand for the heat source is switched off, only the excess heat in the thermal store (PV, solar thermal heating, fireplace...) will be used for heating.

Timer - the timer function allows you to enter 2 time periods in one day, during which the pool will be heated.

E9. Holidays

The Holidays function is designed for background heating of the building during an extended absence. The ON/OFF button can be used to switch the Holidays function on or off.

When the Holidays function is switched on, it is important to set the time and date for the start and end of the Holidays function. For each heating zone and hot water heating, the temperature to which the zone will be heated during the holiday period can be set.

If the heated space is divided into multiple zones, the ON/OFF buttons can be used to determine whether the Holidays function is activated for the whole or for individual zones only. If a hot water recirculation or ventilation zone is connected, the ON/OFF button can be used to select whether the specific function will be active during the holiday period.

E10. DHW Menu (HOT WATER)

The DHW menu opens by clicking on the DHW tile.

If the hot water recirculation function is switched on, there is also a CIRCULATION tile.

E10.1. Domestic hot water

Hot water heating can be switched on or off using the **ON/OFF** button.

In the upper part of the page, the COMFORT/SETBACK status of the zone and the current and desired temperature in the hot water tank are displayed.

In addition to the heat pump, another auxiliary source can participate in the heating of domestic hot water.

In case of high requirements for the DHW temperature, the following message will be displayed below the desired temperature: **Too high desired temperature, auxiliary heat source will be used.**

On the HOME page in the DHW tile, this status is signalled by .

If the auxiliary heat source is switched off and the hot water demand exceeds the capacity of the heat pump, the message **The desired temperature reduced** is displayed in the same place.

On the HOME page of the DHW tile, this status is indicated by . In this case, the desired temperature will be decreased to avoid cycling and heat pump failures.

E10.2. Setting the desired temperatures

Desired temperature (°C) – Setting the desired DHW temperature. The temperature can also be changed using plus and minus keys.

Decrease during setback time (°C) – Setting by how many °C the desired DHW temperature will be decreased during setback time.

Setting the desired DHW temperature. The decrease value can also be changed using plus and minus keys.

The decrease during setback time can only be set with the time program switched on.

One-time heating (°C) – Setting the desired DHW temperature for one-time heating function. The temperature can also be changed using plus and minus keys.

The time program setting is identical to the time program setting in zones 1-6.

If recirculation or Anti-Legionella function is enabled at the service level, the tile for their setting will be shown in the DHW menu.

E10.3. Hot Water Recirculation Settings

The DHW recirculation by auxiliary source can be switched on or off by the user with the **ON/OFF** button.

Setting intervals

Recirculation time - setting the running time of the circulation pump (pump running)

Delay time - setting the delay time of the circulation pump (pump stopped)

The time program settings are identical to the time program settings in zones 1 - 6.

Use DHW zone time program - to start the circulation pump, a time program is set identical to the time program of DHW heating by the heat pump

The circulation pump starts according to the set intervals (circulation time and delay time) only in comfort mode according to the time program.

Immediate circulation

After activating this function, the circulation pump is switched on immediately and runs for the set time. After this time, the function switches back to automatic mode according to the time program.

E10.4. Anti-Legionella

The function can be switched on/off by the user with the **ON/OFF** button.

The top of the page shows the DISINFECTION IN PROGRESS/INACTIVE status and the date and time when the desired temperature in the hot water tank was last met by the Anti-Legionella function.

Setting Anti-Legionella function

Temperature for Anti-Legionella – Setting the desired temperature of the hot water tank during the Anti-Legionella function.

Weekday and hour of function execution – Setting which day and at what time the function will start.

Immediate start – ON/OFF button for immediate start of hot water tank disinfection.

E11. Sources Menu (SOURCES)

In the Source menu it is possible to display parameters and adjust some settings of all system sources (heat pump, switched and modulated sources, solar thermal system, fireplace). If an electric heating element is used for hot water heating (auxiliary source for DHW), the DHW el. element tile is displayed in the Sources menu.

E11.1. Heat Pump

The heat pump can be switched on or off by the user with the **ON/OFF** button.

Current status of the heat pump, information on compressor operation (for inverter models, also compressor speed).

Heat pump operation statistics - operating hours and number of starts.

Statistics of DHW heating by heat pump – operating hours and number of starts.

COMPRESSOR	RUNNING (50.1 rpm)	OVERALL STATISTICS		DOMESTIC HOT WATER STATISTICS	
HP STATUS	min.run time - DHW	TOTAL	4329 : 00	TOTAL	495 : 00
		STARTS COUNTER	1479	STARTS COUNTER	323
FLOW TEMPERATURE	49.0 °C	TODAY	0 : 3	TODAY	0 : 3
INLET TEMPERATURE	42.5 °C	STARTS COUNTER	1	STARTS COUNTER	1
HP RUNNING ALREADY	00:03:03	YESTERDAY	0 : 47	YESTERDAY	0 : 46
HP IDLE ALREADY	00:00:00	STARTS COUNTER	2	STARTS COUNTER	2

Heat pump inlet temperature (heating return) and heat pump outlet temperature.

Time period of the current heat pump cycle. How long the pump has been running or idling in the current cycle.

E11.2. Solar Heating

The solar circuit can be switched on or off by the user with the ON/OFF button (the safety recooling functions remain in operation when switched off).

The solar circuit allows heating of up to three solar appliances.

Current temperature of solar collectors

Solar pump operation information

SOLAR COLLECTORS TEMPERATURE	55.4 °C	SOLAR PUMP	
------------------------------	---------	------------	--

	SOLAR CONSUMER 1	<input checked="" type="checkbox"/>	ON
	Consumer for collector cooling		
Heating		YES	
Temperature		48.0 °C	
Demand		<input type="text" value="70"/> °C	
Maximum temperature		80 °C	

Current temperature: temperature measured by the hot water tank sensor. **Desired temperature:** desired temperature for solar heating of a given hot water tank. **Maximum temperature:** limit temperature for heating from the solar thermal system.

During commissioning, the service technician sets the correct differential values for switching on and off the solar thermal system. He will adjust solar appliances and their values to the current system requirements to ensure long service life and efficiency of solar heating.

E11.3. PV (Photovoltaic system)

The cooperation of the PV system with the IR controller depends on the degree of system interconnection (type of inverter, PV modules used and other components in the system).

From simpler applications, where the IR controller switches the DHW heating, the heating of the thermal store or a combination of both after receiving a request (signal) from the inverter, to more complex systems, where the power overflows are consumed by the heat pump (the speed of the heat pump compressor is automatically adjusted to the PV power output) or are consumed by the heating element (through SSR relays the individual elements of the heating element consume the current overflow on individual phases).



If the PV system is enabled at the service level, a photovoltaic panel will be displayed in the diagram with information about the PV plant performance. (The performance display depends on the inverter used.) Via the information link (i) at the PV panel, you can move to the PV diagram.

PV diagram

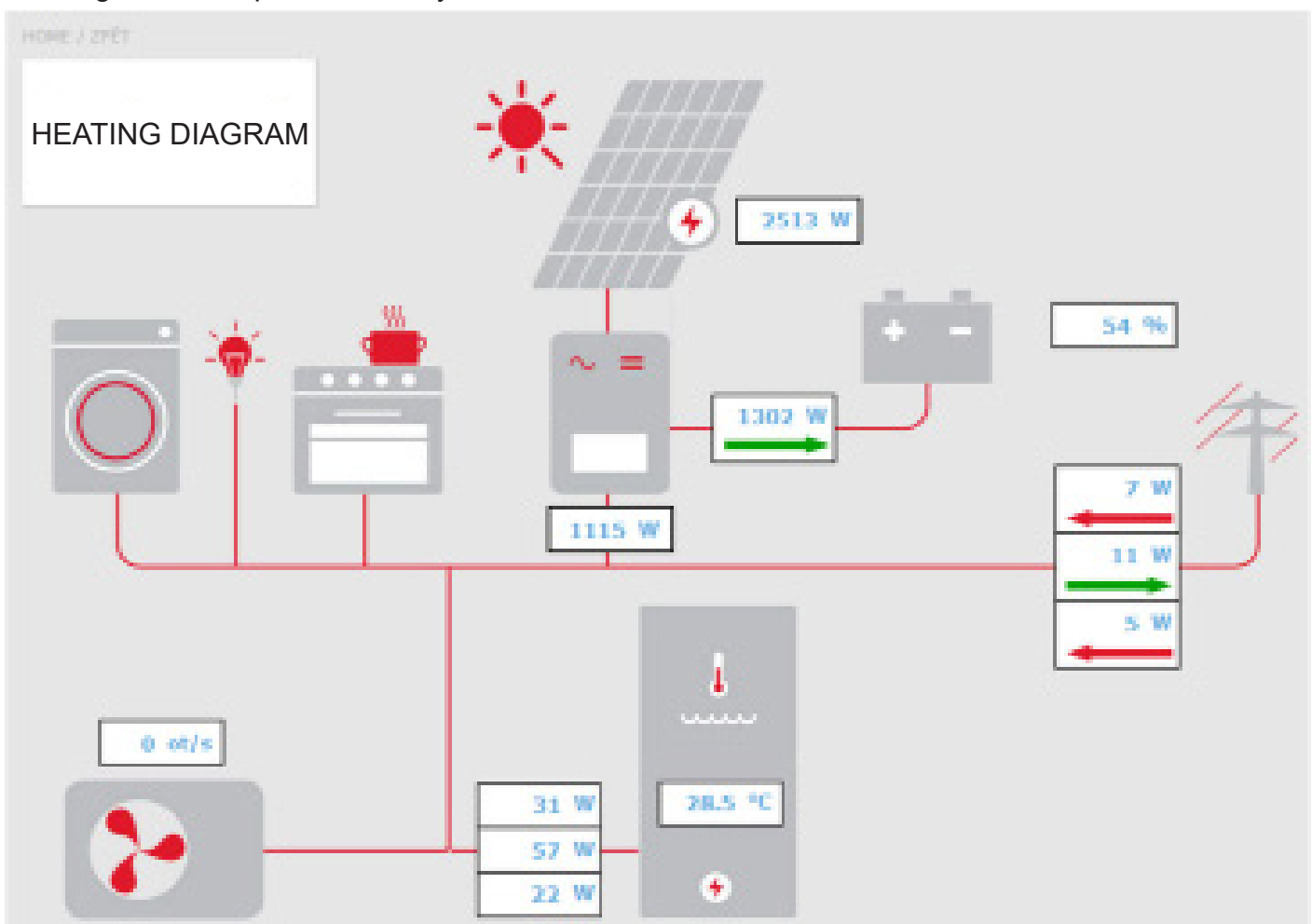
Depending on the individual components wiring, the individual elements of the system are shown in the diagram of the photovoltaic system.



HEATING DIAGRAM tile – it is used to return to the main diagram of the controller.

 Arrows in the diagram show the direction of electric current flow. The red arrow indicates consumption from the power grid, or consumption from the battery. The green arrow  indicates overflow into the power grid, or battery charging.

Current power input of el. heating element – If the function of utilizing the excess power from PV system by an electric heating element is activated, the current power input on individual heating elements is displayed here.

Heat pump – If the heat pump is running, the speed of the compressor is displayed here.

PV system menu

Via the tile SOURCES → PV, you can get to the photovoltaic system menu.

The function of utilization of PV system power overflow can be switched on/off with the **ON/OFF** button.

Utilization of excess solar power by HC temperature increase – The function enabling temporary temperature increase in a zone can be switched on separately for each zone with the ON/OFF button.

Increase of comfort temperature – setting by how many °C the desired temperature in the given zone will be increased.

Thermal Store temperature limit above which the function is active – setting the value of thermal store temperature above which the function will be activated.

E11.4. Fireplace, Solid Fuel Boiler

Control of solid-fuel boiler pump.

The screenshot shows a control interface for a fireplace pump. It includes several data points and control options:

- Current measured values on the control sensors for switching the boiler pump:** FIREPLACE OUTLET WATER TEMPERATURE (50.3 °C) and THERMAL STORAGE (48.9 °C).
- Status of boiler pump:** A rotating red triangle icon indicates the pump is running; a gray triangle indicates it is stopped.
- Differences for switching the pump on/off:** ON (5 °C) and OFF (3 °C). A note specifies: "Difference between fireplace and thermal store temperatures to control pump".
- Limits for switching the pump on/off:** TH. STORE MAX TEMPERATURE (95 °C) and FIREPLACE MINIMUM TEMPERATURE (55 °C).

Callouts provide further explanation: "Differences for boiler pump control." and "Limitation of the minimum temperature at the boiler sensor for switching on the pump and of the maximum temperature of the thermal store for switching it off."

Temperature difference for pump control

SWITCHING ON - switch-on difference; if the real temperature measured by the boiler sensor rises by the value of the switching difference above the temperature in the HW storage tank, the pump is switched on

SWITCHING OFF - switch-off difference; if the difference between the boiler temperature and the temperature in the HW storage tank is lower than the switch-off difference, the boiler pump is switched off

Setting the minimum temperature

The factory set temperature is 65 °C. The value can be changed by overwriting.

E11.5. RegulusHBOX K Electric Heating Element

An auxiliary heat source consisting of a three-phase electric heating element is connected in series with the heat pump in the power supply of the RegulusHBOX K unit. The heating element is controlled automatically according to the required temperatures for space or hot water heating. The heating element can be switched off completely or its individual phases can be switched off.

Using the ON/OFF button, the heating element can be switched on or off by the user. At the top of the page you will find information about the temperature on the control sensor and the desired temperature for space and hot water heating. On the right side of the page the information about the currently switched outputs of the controller (currently switched phases of the heating element) is shown.

In the heating element, it is possible to switch off or on the control of the respective phase (L1, L2 or L3). This reduces the output of the heating element - the heating cartridge has a power of 2 kW per one phase, i.e. the entire heating element has 6 kW.

Automatic control of the output of the heating element (adjustable on the service level) regulates the instantaneous output of the heating elements so that the desired temperature is reached with minimum use of electricity (heating by the heat pump is always preferred). At the bottom of the page there is information on the operation of all three heating cartridges (they are three for one heating element).

In order to avoid unnecessary switching on of the auxiliary source and thus increased expenses for electrical energy, certain conditions must be met for switching on the auxiliary source.

Source blocking by Ripple control – If Ripple control is connected to the controller and blocking during a high tariff is switched on at the service level, the auxiliary source will only be switched on during a low tariff and when also other conditions are met.

Source blocking by outdoor temperature – The factory set temperature for source blocking is 5 °C. (The value can be changed on the service level.)

If the outdoor temperature is higher, the auxiliary source will not be switched on upon request; if it is lower and the other conditions are met, the auxiliary source will be switched on.

Auxiliary source switch-on difference – If the temperature of the heating water at the control sensor drops by the value of the switching difference and the previous conditions are met, the time countdown will be activated (switching delay).

Remaining time to switch source – If during the countdown the conditions are not met at the control sensor (the heat pump does not reach the required temperature of heating water), the auxiliary source is activated.

The most common reason for the unnecessary switching on of an auxiliary heat source is a large difference between the desired room temperature and the decrease during the setback time, when the demand for heating water increases and thus the switch-on difference is met. (From the point of view of optimum operation of the heat pump, a maximum difference between comfort and setback temperature of 2 °C is recommended.)

If the REGULUS HBOX K source is used as the MAIN source of heating (the heat pump is not connected), it is controlled only by the switch-on and switch-off difference, blocking by Ripple signal or other external blocking (external switching). Blocking by outside temperature and switching delay is not supported in this case.

Auxiliary source ON when HP fails ... If this function is enabled at the service level, in the event of a heat pump failure, the auxiliary source will be set as the main source.

If the user does not regularly check the condition of the device, it is not possible to determine whether there is a fault in the heat pump or another part of the system. This could lead to increased costs for operating both the space and hot water heating.

E12. Menu for Other Settings (OTHER)

E12.1. Inputs and Outputs

After clicking on the Inputs/Outputs tile, tables with current information about all sensors, sources, pumps, add-on modules and three-way valves are displayed. This is a complete overview of all connected and unconnected inputs and outputs from the controller.

E12.2. Access and Password

In the Access and Password menu, the login data to the IR controller can be changed. There is also the option of setting MAC addresses for access from the local network without the need to enter a password.

E12.3. General Settings

Here is the information on the synchronization of time and date that is needed for the proper functioning of the time programs for individual zones. There is also the option to turn off the transition to daylight saving time. The system language of the controller is also set here, it can be changed by clicking on the flag.

E12.4. Function Overview

All functions of the controller are displayed in the Function Overview.

Depending on the selected controller setting, the service- and user-switched functions are highlighted here.

E12.5. Fault history

Display of the heat pump fault history and history of other system faults (sensors, communications, modules ...). If the fault is active, it is highlighted in red. Faults written in gray are inactive and are only recorded here.

All faults are recorded in the error log for download.

To download it, click on the icon in the upper right corner of the page.

E12.6. HRV Zone / HRV2 Zone

2 separate HRV units can be controlled by the IR controller.

The settings of HRV 2 is identical with those of HRV.

The screenshot shows a control interface for HRV units. It features a table with two columns. The left column displays 'CONTROL SENSOR TEMP.' with a value of '19.1 °C' and 'POWER' with a value of '15 %'. The right column displays 'UNIT STATE' with a value of 'SWITCHED OFF BY USER' and 'SUMMER BYPASS' with a value of 'INACTIVE'. Two callout boxes are present: one pointing to the temperature and power values, and another pointing to the unit state and summer bypass flap status.

CONTROL SENSOR TEMP.	19.1 °C	UNIT STATE	SWITCHED OFF BY USER
POWER	15 %	SUMMER BYPASS	INACTIVE

Performance Settings for HRV Unit

Comfort - Setting the performance of the HRV unit in comfort mode.

Setback - Setting the performance of the HRV unit in setback mode.

The performance in the setback mode can only be set with the time program switched on.

The time program settings are identical to the time program settings in zones 1 - 6.

Filter service settings

Setting the service interval of the filter and the possibility to confirm its replacement. The function calculates the operating hours of the HRV unit and, at the end of the filter service life, alerts the user to the need to replace it.

Temporary boost 1, 2, 3

The temporary boost can be switched on or off with the **ON/OFF** button.

Up to 3 temporary boost periods can be preset and then activated in these sections. When the boost function is switched on, the HRV unit sets the performance to the value set in the **Required performance** field for the **Boost time**. After this time, the function is deactivated and the HRV unit returns to automatic mode.

Summer bypass function

The summer bypass function can be switched on or off with the **ON/OFF** button. In this section, the desired temperature and the relative heating zone are set (a room sensor must be located in this zone). If the room temperature in the heating zone is higher than the set limit and at the same time the conditions for the outdoor temperature (set at the service level) are met, the summer bypass opens.

While the function is running, it is possible to set a constant performance of the HRV unit (the unit then ignores the time program and the alternation of comfort / setback modes).

Time limited performance function

The function can be switched on or off with the **ON/OFF** button.

This function can be used, for example, for the HRV night setback. The % of performance and the setback time are set here.

Cooling function

If enabled on the service level, the cooling function is displayed in the HRV menu.

The cooling function can be switched on or off with the **ON/OFF** button.

In this section it is possible to enter the required temperature of the cooling water and set the cooling parameters.

Cooling dependent on the outdoor temperature means that the cooling to the heat recovery ventilation system starts only if the outdoor temperature is above the set outdoor temperature for switching on the cooling. If the outdoor temperature drops below the outdoor temperature for switching on the cooling, the cooling is deactivated again.

While the function is running, it is possible to set the constant performance of the heat recovery ventilation unit (the unit then ignores the time program and the alternation of comfort/setback modes).

For cooling, the restrictions in chap. A2.2 apply.

To activate the heat pump for cooling mode, it is necessary to turn on the option of cooling from the heat pump in the heat pump menu.

E12.7. Universal Outputs (Universal functions)

If the function is switched on at the service level, the UNI function 1 (UNI additional module) or UNI function 2 (UNI 2 additional module) menu is displayed.

In the upper left part, the temperatures at the control sensors are displayed, temperature t1 is for thermostat 1, temperature t2 is the temperature for thermostat 2.

In the upper right part, information is displayed as to whether the function is active or inactive (whether or not heating is in progress).

Most commonly, the UNI function is used to control a pool or to control a three-way valve between two tanks. But it can also be used for other functions based on thermostat control, temperature difference, timer and their combination.

A universal function consists of sub-functions connected in series. The output is therefore switched on only if the conditions for switching on all functions in series are met.

For example, if just the Thermostat 1 parameter is activated, the UNI function will be switched on when the Thermostat 1 switch-on condition is met. However, if the parameters Thermostat 1, Thermostat 2 and Timer are activated, the UNI function will be switched on only after the conditions for all these 3 activated parameters are met.

For easier orientation, the basic principles of universal functions will be explained further and their practical use in the most frequently used application, pool heating, will be shown. Settings of other applications of these functions is similar.

UNI Additional module (UNI function 1)

The UNI function 1 can be switched on/off with the **ON/OFF** button.

THERMOSTAT 1 It is used in situations where it is desirable to use in the application thermostatic switching on/off based on the temperature t1 overshoot or undershoot.

For example, an installation with solar thermal or photovoltaic panels, where excess heat is used to heat the pool only when a certain temperature of the thermal store is exceeded, and thus solar heat is preferred for hot water or space heating. (The purpose is not to cool down the tank below a certain temperature.)

Desired temperature (°C) Setting the desired temperature in thermal store when the conditions are met for switching on the parameter.

Switch on/off difference A parameter adjustable at the service level, for the user the value is only displayed. It determines the temperatures at which thermostat 1 will switch on/off.

A typical setting of Thermostat 1 when using excess energy for pool heating is: the desired temperature 55 °C with switch-on difference 0 °C and switch-off difference -5 °C. With the parameters set in this way, the UNI function will be switched on when the temperature of 55 °C is reached at the control sensor (temperature t1) and switched off again when the temperature t1 drops by 5 °C to 50 °C.

THERMOSTAT 2 Similarly to Thermostat 1, also Thermostat 2 is used in situations when it is desirable to use in the application thermostatic switching on/off based on the temperature overshoot or undershoot but this time at the sensor labelled temperature t2.

Thermostat 2 in the pool function is used to set the desired temperature and display the parameters of the pool water temperature differences.

Desired temperature (°C) Setting the desired pool temperature when the conditions are met for switching on the parameter.

Switch on/off difference A parameter adjustable at the service level, for the user the value is only displayed. It determines the temperatures at which thermostat 2 will switch on/off.

A typical setting of Thermostat 2 when used in the pool function is:

the desired temperature 28 °C with switch-on difference -0.5 °C and switch-off difference -0.5 °C. With the parameters set in this way, the UNI function will be switched on when the pool temperature drops by 0.5 °C (control sensor is temperature t2) and switched off again when the temperature t2 rises by 0.5 °C above the desired temperature 28 °C.

Request for heat source with the ON/OFF button, you can choose whether the heating source will be used to heat the pool. When the demand for the source is turned off, only the excess heat in the thermal store (PV system, thermal solar heating, fireplace...) will be used for pool heating.

Timer the timer function allows you to enter 2 time periods in one day during which the pool will be heated. The timer function is superior to all previous functions.

UNI 2 Additional module

The UNI function 2 can be switched on/off with the **ON/OFF** button.

The UNI function 2 setting is identical with the UNI function 1 setting.

For pool purposes, UNI function 2 can be used, for example, to control filtration. Using the timer, you can set 2 time periods in one day when the pool will be filtered.

UNI function 2 can be combined with UNI function 1 and switch on filtration while the pool is being heated.

E12.8. RegulusRoute

Information about remote controller management is displayed in the RegulusRoute menu. You will use this information to communicate with the service technician in case the controller is unavailable through the RegulusRoute service for any reason.

E13. Manual Access Menu (MANUALS)

In the Manuals menu you will find this manual and the manuals for the RCM and RCD room units.

F. ADJUSTING THE CONTROLLER THROUGH THE SERVICE DISPLAY

Warning: The service display is located in the electrical installation section of the device, where the live components are located. Therefore, the service display can only be operated by a service technician with electrical qualification.

F1. Controller Input

In the menu, scroll through the displays using the ▲ ▼ buttons. Increase/decrease the numerical parameters with the ▼ or ▲ buttons. Select the parameters to be selected (e.g. on/off) with the ◀ ▶ buttons. To edit one of the parameters, press the ✓ button and the cursor will appear on the parameter. To finish editing the parameter, press the ✓ key, the cursor automatically jumps to the next parameter on the current display. Parameter editing can be terminated without saving the newly set value with the ✕ key. Pressing the ✕ key in the user basic menu always returns the menu to the first - basic display.

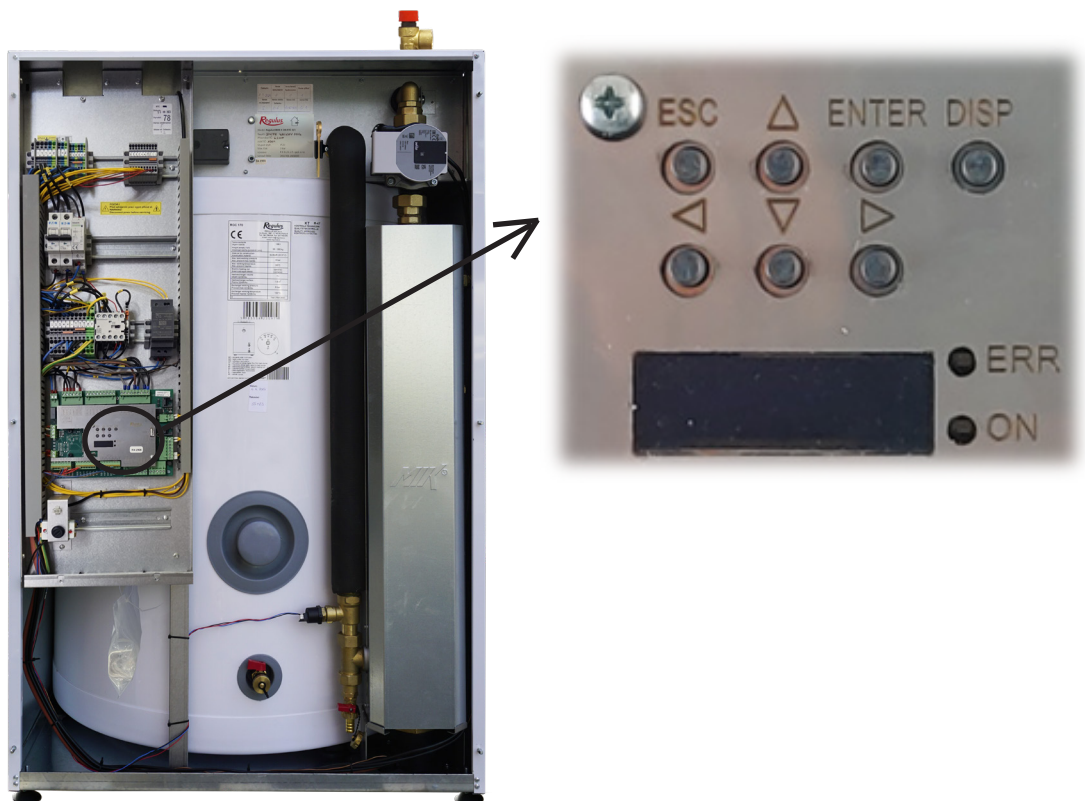

F2. Overview of Parameters Displayed on the Service Display

F2.1. Basic Display

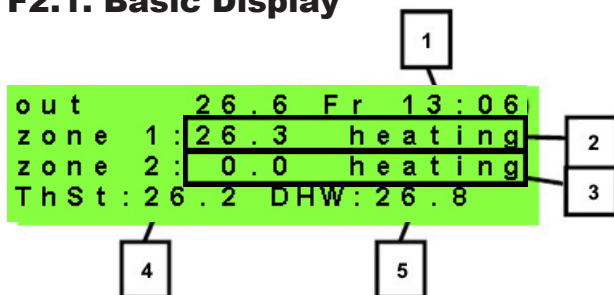

- 1 - day of the week and time
- 2 - zone temperature (if a room temperature sensor is used)
- 3 - heating water temperature (if no room temperature sensor is used)
- 4 - temperature in the thermal store (if present in the system)
- 5 - temperature in the hot water storage tank

F2.2. Zone Display (zone 1, zone 2)

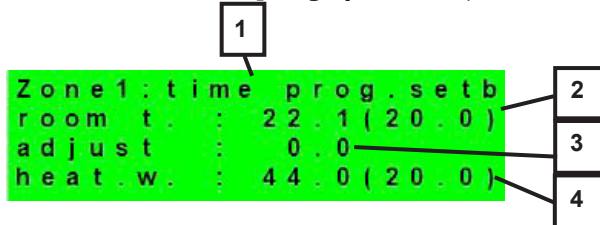

- 1 - zone status (information on the current status of the heating zone)
- 2 - actual and desired room temperature (if a room sensor is not used, the value is 0.0)
- 3 - correction of the desired room temperature; when a room unit is used, the „PJ“ symbol is displayed and the correction by this unit is displayed
- 4 - actual and desired heating water temperature to the zone

The table below lists the possible operating states indicated on the service display and their equivalent in the web interface of the controller:

Indication on the service display	Indication on the web interface
off by service	DISABLED BY SERVICE
off by user	DISABLED BY USER
low syst.press	TOO LOW SYSTEM PRESSURE
extern. block	BLOCKED EXTERNALLY
store low t-HP	THERMAL STORE BELOW HP MIN. TEMP.
fast loading	FAST BOILER/FIREPLACE LOADING
stor.low t-zon	THERMAL STORE BELOW ZONE MIN.TEMP.
max.z.temp.exc	MAX. ZONE TEMPERATURE EXCEEDED
block-cool.t.	COOLING BELOW ZONE TEMPERATURE
cool.other z.	COOLING IN ANOTHER ZONE
block-period	HEATING BLOCKED IN SET PERIOD
block-outd.t.	HEATING BLOCKED BY OUTDOOR TEMPER.
off-time prog.	TIME PROGRAM – SETBACK, ZONE OFF
block-room t.	ROOM TEMPERATURE REACHED
air cooling	AIR COOLING
cool. active	COOLING ACTIVE
floor drying	FLOOR DRYING PROGRAM
comf-low out.t	COMFORT - LOW OUTDOOR TEMPERATURE
time prog.comf	TIME PROGRAM – COMFORT TEMPERATURE
time prog.setb	TIME PROGRAM – SETBACK TEMPERATURE
th.st.overheat	THERMAL STORE OVERHEATED
holidays	HOLIDAYS
perm. comfort	COMFORT TEMPERATURE CONTINUOUS
perm. setback	SETBACK TEMPERATURE CONTINUOUS
DHW heating	DHW BEING HEATED
heat.- holid.	HOLIDAYS
cool. holid.	HOLIDAYS

F2.3. Solar Thermal System Display

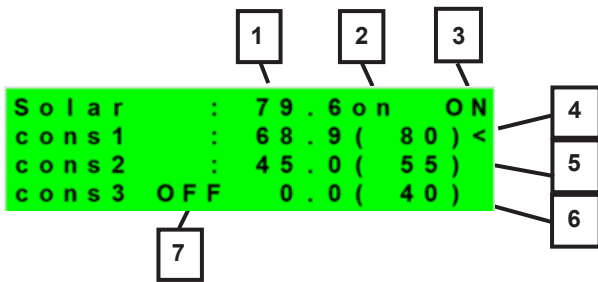

- 1 - solar collector temperature
- 2 - turn on the system
- 3 - ON = solar pump running
- 4 - mark of the currently heated hot water storage tank
- 5 - HW storage tank 1, actual temperature (desired in solar heating)
- 6 - HW storage tank 2, actual temperature (desired in solar heating)
- 7 - HW storage tank 3, not used

F2.4. Display of Hot Water Zone

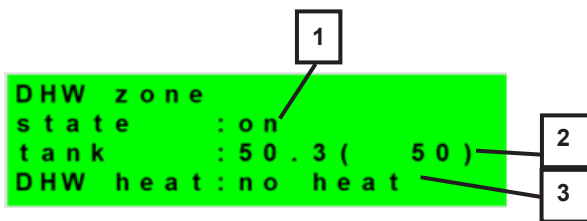

- 1 - zone status (on / off / no)
- 2 - actual and desired temperature in the HW storage tank
- 3 - heating by electric cartridge (heating / no heat.)

F2.5. Display of Heat Pump, Heat Pump Cascade

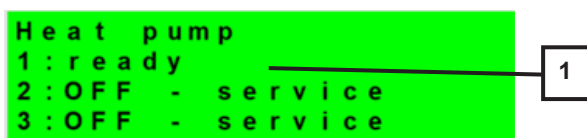

- 1 - status of heat pump No. 1, No. 2 and No. 3.
- This section shows the states of the heat pumps that are enabled at the service level.

The states can be as follows:

OFF - service	heat pump is turned off by a heating engineer
OFF - user	tepelné čerpadlo je vypnuto v uživatelské úrovni regulátoru
je v poruše	heat pump is turned off on the User level
return - max.T	heat pump is blocked by max. possible return temperature
flow - max.T	heat pump is blocked by max. possible flow temperature
ambient – min.T	heat pump is blocked by min. possible outdoor temperature
ambient – max.T	heat pump is blocked by max. possible outdoor temperature
sup.refrig.vapor	heat pump is blocked by max. compressor temperature
high T earth circ.	heat pump is blocked by max. brine circuit temperature
current out of range	heat pump is blocked (supply current is outside the preset range)
phase curr.o.o.range	heat pump is blocked (supply current of a phase is outside the preset range)
IPM module protect.	heat pump is blocked by protection of internal electronics
comp. lubricating	lubrication of the heat pump compressor is in progress
high press.switch	heat pump is blocked by high refrigerant pressure at the pressure switch
high pressure	heat pump is blocked by high refrigerant pressure
comp. preheating	compressor preheating before starting the pump in low ambient temperatures
evaporator low temp.	heat pump is blocked by evaporator low temperature
voltage out of range	heat pump is blocked (supply voltage is outside the preset range)
out.temp. o.o.range	heat pump is blocked (outdoor temperature is outside the set limits)
power restr.out.temp	heat pump performance is limited due to high outdoor temperature
comp.restr.cond.p.	heat pump compressor performance is limited by the condensing pressure
defrosting	heat pump is defrosting (only for air/source heat pumps)
min.run time	HP min. running time is active. This activates always after start, DHW heating or defrosting
DHW heating	heat pump is heating DHW
rebooting	heat pump is blocked by min. time between 2 comperssor stars
heating	heat pump is heating your home
RC blocking	heat pump is blocked by Ripple control
vol.flow control	heat pump's circulation pump is running
ready	heat pump is ready to start heating as soon as there is call for heat
IR internal error	controller error preventing successful start of the heat pump
external blocking	the start of the heat pump is blocked externally
PWM mod.disconnected	the PWM output module is disconnected (if used)
PWM pump failure	failure of the circulation pump controlled by the PWM signal
low flow	water flow through the heat pump is too low
waiting for PV	heat pump is waiting for a PV system to reach the desired values of current to start
min.run time - DHW	DHW - min. running time of the heat pump when heating DHW
min.run time - PV	PV - minimum running time when the heat pump is power supplied from a PV system
heating from the PV	PV energy is used for the heat pump
cooling	heat pump is used for cooling
flow - min.T	heat pump is blocked by min. flow temperature

F2.6. Display with Firmware Version and Release Date

```
IR RegulusHBOX K RTC
FW: v1.0.8.0
07.03.2024
www.regulus.cz
```

F2.7. Controller in Factory Settings

If there is the screen shown on the display (see below) with a warning about setting the controller to factory settings, it is necessary that a service technician sets the relevant parameters of the controller.

```
!WARNING!
After failure
controller reset to
FACTORY SETTINGS!!!
```

F2.8. Select the Desired Setting (menu)

```
*****
* settings *
* < for user > *
```

User settings	user settings of zones, DHW heating and other parameters, structure of settings in more detail in the following chapter: Heating zones ► HRV zone ► Time program ► Weather-compensating curves ► Heat pump control ► Heating element control ► HP faults ► Other faults ► Setting the DHW heating from the heat pump (DHW-HP) ► Setting the DHW heating via an auxiliary source (DHW-E) ► Thermal store heating settings ► DHW recirculation settings ► Statistics ► Operating data ► Others ► Date and time settings ► RegulusRoute - service connection parameters
Additional modules	display of basic information from additional modules, if used
Service settings	service settings of zones, hot water heating, sources and other parameters Access to the service menu is password protected and parameter settings in the service menu can only be performed by professionally qualified persons!
Recirculation	setting the immediate DHW recirculation (circulation time); after the set circulation period ends, the function switches off automatically
Z3 to Z6	basic settings for heating zones 3 to 6 (these zones need to be connected to the IR through additional modules)

F3. User Settings

Use the ◀ ▶ buttons to select between the options in the user settings; confirm the selection with the ✓ button; after completing all settings, press the × button to return to the first - basic display.

F3.1. Heating Zones

Basic settings of the heating zone

Desired temp. (°C)	desired room temperature in zone
Decrease during setback time (°C)	setting by how many °C the desired room temperature will be decreased during setback time <i>day the controller switches the desired room temperature according to the set time program (for zones 3 to 6 adjustable only from the web interface)</i>
zone on	switching on the heating zone by the user; if the zone is switched off by the user, the circulation pump is switched off and the mixing valve is shifted to the closed position <i>the pump and valve can be switched on by frost protection (if switched on and active)</i>

Winter/Summer function

The winter/summer function is used to switch on the zone heating if the outside temperature is below a set temperature (**winter temperature**) for a certain time (**winter time**) and vice versa to switch off the zone heating if the outside temperature is higher than the set temperature for switching to summer mode (**summer temperature**) for a certain time (**summer time**).

Status	switching on/off the function for automatic transition between summer and winter mode
summer temp (°C)	if the outdoor temperature is above this temperature for the time specified in the summer time parameter, the zone switches to <i>summer mode</i>
summer time (h)	see parameter <i>summer temperature</i>
winter temp (°C)	if the outdoor temperature is below this temperature for the time specified in the winter time parameter, the zone switches to <i>winter mode</i>
winter time (h)	see parameter winter temperature

F3.2. HRV Zone

Basic settings of HRV zone

comfort (%)	setting of the HRV unit performance in the „comfort“ mode in the range 0-100%
setback (%)	setting of the HRV unit performance in the „setback“ mode in the range 0-100%
zone on	switching on the HRV zone by the user

During the day, the controller switches the desired performance of the HRV unit according to the settings of the time program (adjustable from the web interface only)

Boost 1, 2, 3 function settings

boost function 1, 2, 3	turning on the instant boost function; the output of the HRV unit increases temporarily for the time period set by the time parameter to the value set by the power parameter; after the set time for boost elapses, the HRV unit switches back to automatic mode; this function can also be switched on with a button wired to one of the controller inputs (see service level)
power (%)	see the Boost 1, 2, 3 parameter
time (hh:mm)	see the Boost 1, 2, 3 parameter

Summer bypass settings

summer bypass	turning on the summer bypass function; this function can be related to the room sensor of one of the heating zones (but only if a room sensor or a room unit is present in the given zone); the sensor used is defined by the parameter assign function to zone ; the function opens the bypass damper if the outdoor temperature is lower than the set room temperature at the selected room sensor (desir.temper. parameter); the outdoor temperature must also be higher than the service-set minimum outdoor temperature; the summer bypass function can be started only in the summer mode of the selected zone (service adjustable parameter)
assign function to zone (zone number 1 – 6)	see the summer bypass parameter
request t. (°C)	see the summer bypass parameter

F3.3. Time Programs

Setting the time program by days - set for each day of the week two transitions from setback mode to comfort mode and two transitions from comfort mode to setback mode.

Setting the time program block by block - set the transitions similarly for the Mon-Fri and Sat-Sun block. Selecting *copy YES* will overwrite the corresponding time program blocks. If you do not wish to copy the time programs, leave the option to *copy NO*, and exit the menu with the **x** button.

Setting the holiday mode - for the set period it is possible to set the temperatures of individual zones to which the controller will regulate the temperature.

F3.4. Weather Compensating Heating Curves

The basic heating curve in the controller is calculated from the parameters of the heating system that were entered on the controller service level. The basic curve can be rotated and shifted using a pair of parameters on the user level.

OTC curve shift (°C) offset of the heating curve for the entered outdoor temperatures of -15 °C and + 15 °C. When moving the curve at one of the points, the other point always remains unchanged (i.e. the curve rotates around it). To shift the entire curve, it is therefore necessary to enter the same value as both shift values.

On other displays it is possible to display the adjusted heating curve described by the four points [E1, I1] to [E4, I4] where E1, E2, E3 and E4 are the entered outdoor temperatures and I1, I2, I3 and I4 are the calculated required weather-compensated heating water temperatures.

F3.5. Heat Pump Control

HP1, HP2, HP3 - User switching on/off one of the heat pumps in the cascade. The heat pump switched off by the user still communicates with the controller, but no requests from the heating system or the hot water system are transmitted to it.

F3.6. HP Faults

In the heat pump faults menu, it is possible to reset the faults of all heat pumps (by changing the Reset all faults option to Yes). Use the down arrow to scroll through the heat pump fault history.

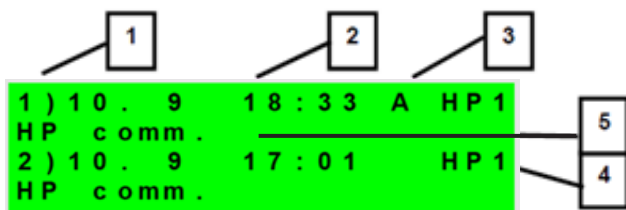

- 1 - serial number of the fault (1 - 10)
- 2 - date and time of failure
- 3 - information if the fault is still active (A)
- 4 - serial number of the HP with a fault (1 - 10)
- 5 - text description of the fault

F3.7. Other Faults

List of recent controller faults except heat pump faults. These faults include, for example, errors of sensors, connected modules, errors of sources.

F3.8. Settings of DHW Heating

DHW on	user activation of DHW heating
Desired temperature (°C)	desired DHW temperature
Decrease during setback time (°C)	setting by how many °C the desired DHW temperature will be decreased during setback time (desired DHW temperature during setback)

During the day, the controller switches the desired DHW temperature according to the set time program.

F3.9. Settings of Thermal Store Heating

During the day, the controller switches the desired thermal store temperature according to the set time program. The actual required thermal store temperature is the maximum of all requirements from the zones (heating zones, ThSt zone, requirements from universal functions ...).

ThSt on	user activation of thermal store heating
Desired temperature (°C)	desired temperature in thermal store
Decrease during setback time(°C)	setting by how many °C the desired DHW temperature will be decreased during setback time (desired DHW temperature during setback)

F3.10. Settings of DHW Recirculation

User setting of hot water recirculation and its time program. If the recirculation is switched on, it is performed following the time program set for each day. For this time interval, the running time of the circulation pump and the delay of the circulation pump can be set, supposed the circulation pump shall not run continuously.

on (off / on)	activation of recirculation function
circ. time (min)	setting the circulation pump running time (pump running)
idle time (min)	setting the circulation pump delay time (pump stopped)
circulation times	setting of time intervals for individual days when the circulation is performed

F3.11. Statistics

Display of heat pump statistics (operating times and number of compressor starts) and operating statistics for hot water and auxiliary source.

F3.12. Operating Data

It shows the user all temperatures, pressure, the most important temperatures and states of the heat pumps and the values at the controller outputs. If the letter E appears at the end of the temperature sensor line, the given temperature sensor is outside its permitted working range and it is necessary to check this sensor and its connection and correct the fault.

```

out      8.2 Tu 18:36
zone 1: 29.6 heating
zone 2:  0.0 heating
ThSt: 45.0 DHW: 50.2
  
```

F3.13. Other

website password reset	reset of username and password to access the controller website on the user level (reset option); reset returns the factory value (name: user, password: user)
language for error messages and HP state:	selection of the language in which the heat pump states, sensor names, blocks and system faults will be shown on the display and on the web

F3.14. Date and Time Settings

For the correct operation of time programs (zones, recirculation, DHW heating...) it is necessary to set the time and date. The clock is set in 24-hour format. If the controller is connected to the Internet, the date and time are automatically updated every hour using NTP time servers.

After setting the time and date and pressing the **▼** key, the display below will be shown. When this display appears, the time and date will be stored in the controller memory.

```
S a v i n g   t i m e           O K
p r e s s   " C "   f o r   r e t u r n
```

F3.15. RegulusRoute - Service Connection Parameters

RegulusRoute service allows remote access to the controller without the need to use a public IP address. Please contact Regulus to configure the service.

RegulusRoute	indicates whether the service is switched on
Status	displays the current service status and error information followed by IR driver status information, the status of the remote server of the RegulusRoute service and a detailed description of the last service error; this information can be helpful when solving connection issues with a service technician
RegulusHBOX K name	RegulusHBOX K login name for RegulusRoute service

F4. Additional Modules

When selecting Additional Modules in the main menu, user information for additional modules can be viewed if they are used in the controller.

F4.1. Fireplace Module

```
F i r e           :
t e m p e r a t u r e : 4 5 . 0 ° C
d a m p e r       : 1 0 0 %
D H W   p u m p   : n o n e
```

Temperature (°C) – displays the fireplace flow temperature.

Damper (%) – displays how opened the fireplace air inlet damper is.

DHW pump – displays the status of the pump for DHW heating from Thermal Store (running/off).

F4.2. UNI Module, UNI Module 2

```
U N I   m o d u l e :
o u t p u t       : n o n e
t e m p .   1    : 0 . 0
t e m p .   2    : 0 . 0
```

Output (on/off) - displays the status of the universal output at the UNI module (1, 2).

T1 (°C) – displays temperature t1 from UNI module (1, 2).

T2 (°C) – displays temperature t2 from UNI module (1, 2).

G. MAINTENANCE

G1. Maintenance by the User

It is recommended to perform this type of maintenance once a month:

- Pressure check (locally or remotely via remote access). If necessary, air vent and top up water to the heating system.
- Visual inspection for possible water leaks from the unit or piping.
- Cleaning the outer casing with non-aggressive and non-abrasive cleaning agents (e.g. a slightly damp piece of cotton cloth).
- Checking the safety valve function (by slightly turning the valve knob).

G2. Removing the Front Cover

The front cover is mounted on six pins located on the side covers. Follow the picture below to remove the front cover.

WARNING: Disconnect the connector with display cable by pressing the connector.

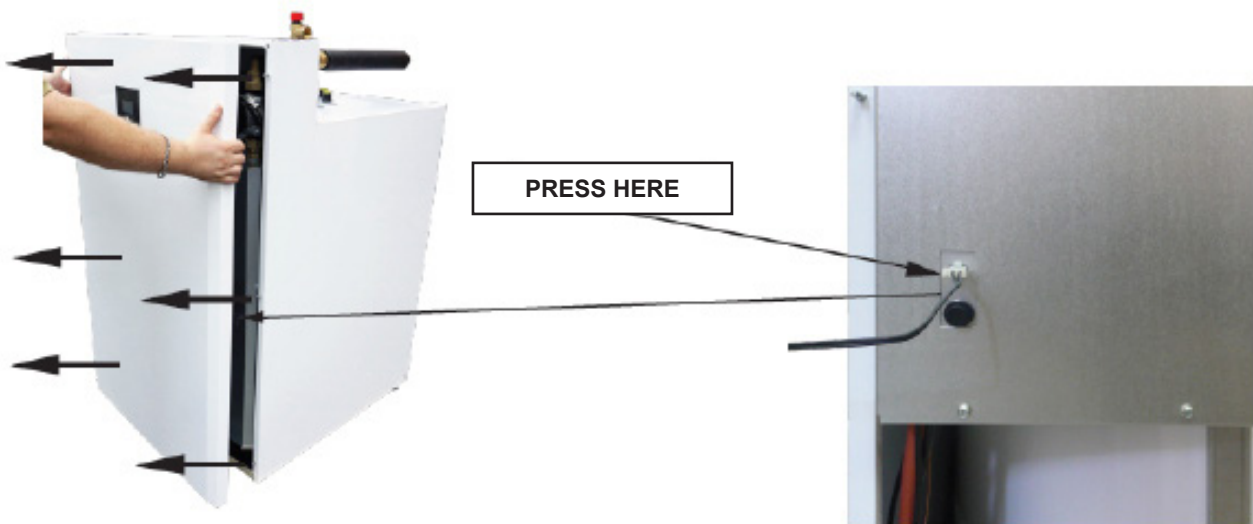

G3. Removing the Wiring Cover

Warning: Danger of electric shock if live parts are touched! Before starting work, disconnect the RegulushBOX K from the power supply (by switching off the relevant circuit breaker in the house switchboard).

Removing the wiring cover may only be carried out by a person professionally qualified in accordance with EN 50110-1!

The cover is attached with two screws at the bottom. After unscrewing them, the cover can be released and removed by moving upwards. The detail of the attachment is shown in the picture below.

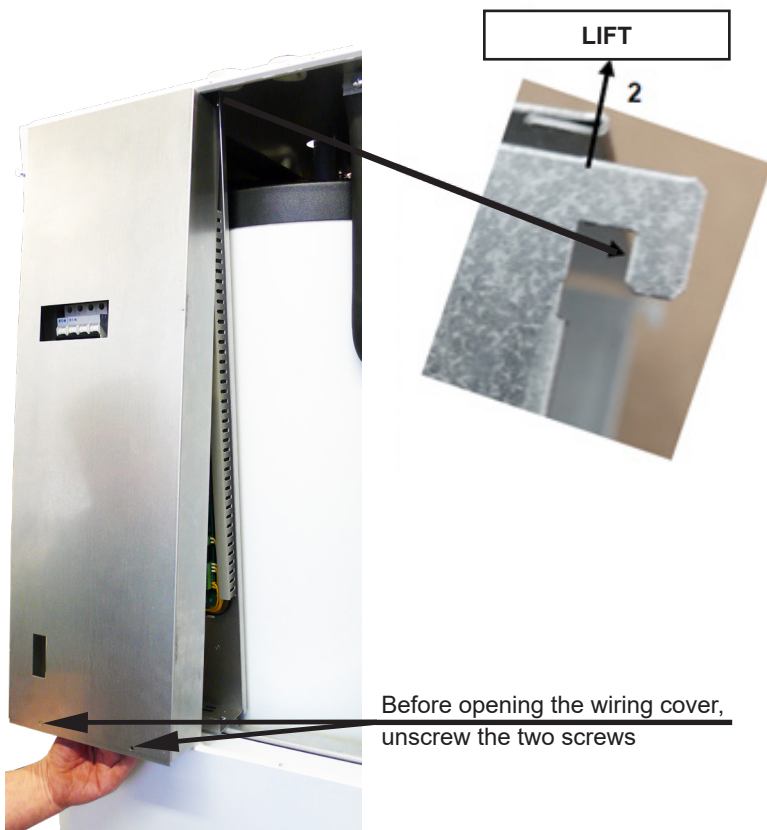

G.4. Professional Maintenance

It is recommended to perform professional maintenance once a year by a service technician with professional qualifications:

- Checking the electrical installation (circuit breakers, contactors, cables) and tightening the connections
- Checking that all safety elements are working properly
- Checking and adjusting the pressure of expansion vessels
- Cleaning the ball valve with filter&magnet in the return piping to the heat pump
- Checking water pressure and tightness of connections
- Checking heating elements, pump and three-way valve

G.5. Discontinuing Operation

If there is a risk of water freezing in the device (e.g. if the device is out of operation in an unheated room), drain all water from the RegulusHBOX K, the heat pump and the pipes - especially in places where the temperature may drop below 0 °C. And also turn off the RegulusHBOX K circuit breaker in the home fusebox.

For draining the system, switch the actuator of the 3-way zone valve (marked as TRV in the diagram) to manual mode, set the control lever to 45° and open the drain valve.

G.6. Recycling / Disposal

The device must not be disposed of with municipal waste.





Dispose of steel, copper and copper alloy components in the sorted metal waste collection.

Electronic components, such as electronic boards, must be handed in at a collection point for electrical waste.

H. SERVICING

Faults of the circulation pump of the heat pump circuit

The operating status and possible faults of the pump are displayed by means of LED signals directly on the pump.

LED signals	State description and possible fault reasons	
	green is lit	– pump is running in trouble-free operation
	red is lit	– rotor is blocked
		– electric motor winding defect
	flashing red	– power supply lower/higher than permitted
		– electric short circuit in pump
		– pump overheated
	flashing red and green	– unforced fluid circulation through the pump
		– pump speed lower than desired
		– air in pump

in case of some faults the pump will switch off and try to restart

Temperature resistance table for Pt1000 sensors

°C	0	10	20	30	40	50	60	70	80	90	100
Ω	1000	1039	1077	1116	1155	1194	1232	1270	1308	1347	1385

H.1. Fault Indication

If a fault occurs, an exclamation mark  appears next to the house icon on the display.



After pressing the button under the exclamation mark, faults will be displayed in this order: on pos. 1-3 heat pump faults, on pos. 4-5 other faults. On position 6 there is a screen for reset of heat pump faults.

H.2. Record of Repairs and Inspections

Date	Operation performed	Service company Name, signature and stamp	Custo- mer's signature

©2024 We reserve the right to errors, changes and improvements without prior notice.

FW 1.0.11.0
updated 11.11.2024

v1.0-11/2024

REGULUS spol. s r.o.
E-mail: sales@regulus.eu
Web: www.regulus.eu

