



www.regulus.eu



CSE MIX-FIX G 5/4M

Installation and Operation Manual
CSE MIX-FIX G 5/4M PUMP STATION
with mixing valve and actuator, constant temperature

EN

CSE MIX-FIX G 5/4M

1. Introduction

CSE MIX-FIX G 5/4M pump station is designed to be installed to a solid fuel boiler return line as a protection against low-temperature corrosion, flue gas condensation and boiler tarring. Further it can be installed to heating circuits, providing circulation of heating water through the circuit and mixing it to a preset constant temperature. A controller with a display ensuring actuator movement and circulation pump switching is integrated in the actuator.

This pump station is designed to be installed directly on the pipe, with 100 mm min. distance of the pipe axis from a wall.

2. Description of the pump station

The pump station consists of a UPM3 FLEX AS pump including power and control cables, a 3-way mixing valve with a constant temperature actuator, incl. a power cable, two temperature sensors, a ball valve and insulation.

Main features	
Application	control of a solid fuel boiler return line temperature or control of flow temperature into a mixed circuit to a constant temperature level
Description	consists of a UPM3 Flex AS pump, a 3-way mixing valve LK 840 with ACC40 actuator (constant temperature control + 2 temperature sensors) and insulation
Function	the pump station keeps a constant temperature at a boiler return line or at a mixed heating circuit flow and turns on/off circulation pump depending on mode and temperature settings
Working fluid	water, water-glycol mixture (max. 1:1) or water-glycerine mixture (max. 2:1)
Installation	return pipe of a solid fuel boiler / flow pipe into a heating circuit, the min. distance of the pipe axis from a wall is 100 mm
Code	16 844

Technical data of CSE MIX-FIX G 5/4M pump station	
Fluid working temperature	5 - 110 °C
Max. working pressure	10 bar
Ambient temperature	5 - 40 °C
Max. rel. humidity	95 % non condensing
Power supply	230 V, 50 Hz
Insulation material	EPP RG 60 g/l
Overall dimensions	325 x 140 x 220 mm
Total weight	4.1 kg
Connections	2 x G5/4" M, 1 x G5/4" F

3. Installation options

The pump station comes with a mixing valve in the right-hand position (see Fig. 1). When needed, the mixing valve can be rotated to the left of the boiler (see Fig. 2). After the valve is turned by 180° and the fittings are tightened, the actuator lock shall be unscrewed and screwed into the opening at the other valve side (see Fig. 3) and the position of the valve member and actuator changed (see the paragraph and figures below).

POSITION TO THE RIGHT OF A BOILER - RIGHT HAND INSTALLATION

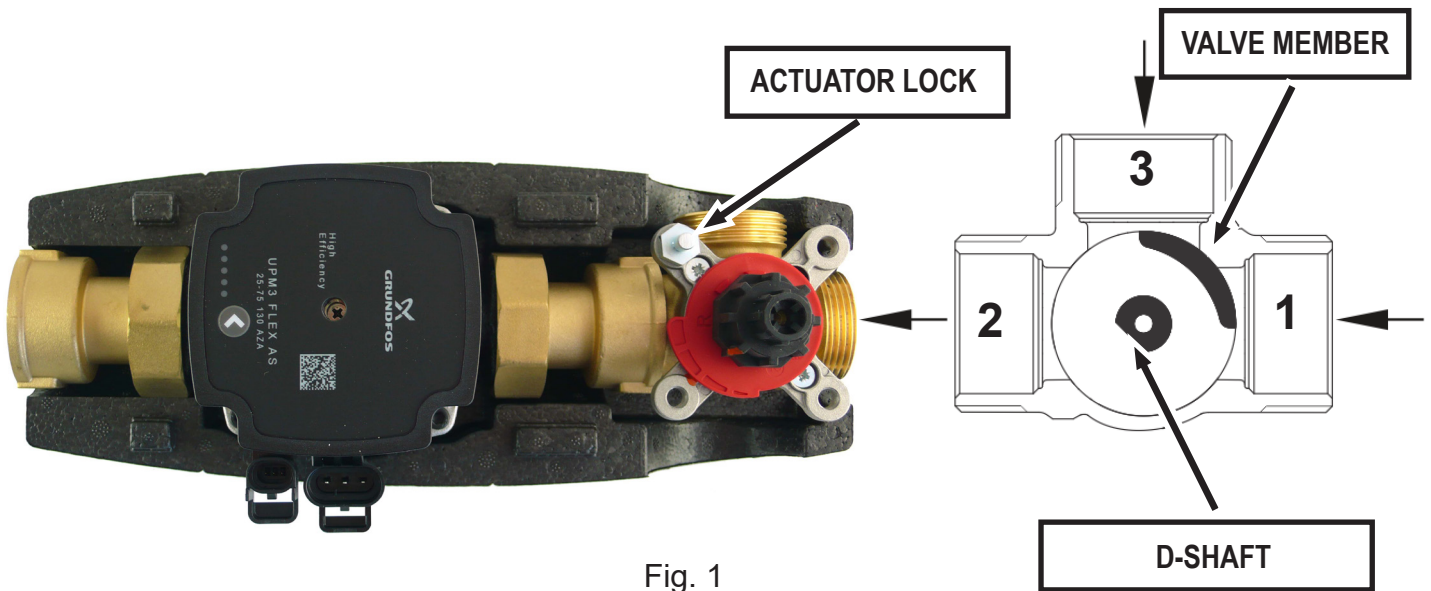

Fig. 1

POSITION TO THE LEFT OF A BOILER - LEFT HAND INSTALLATION

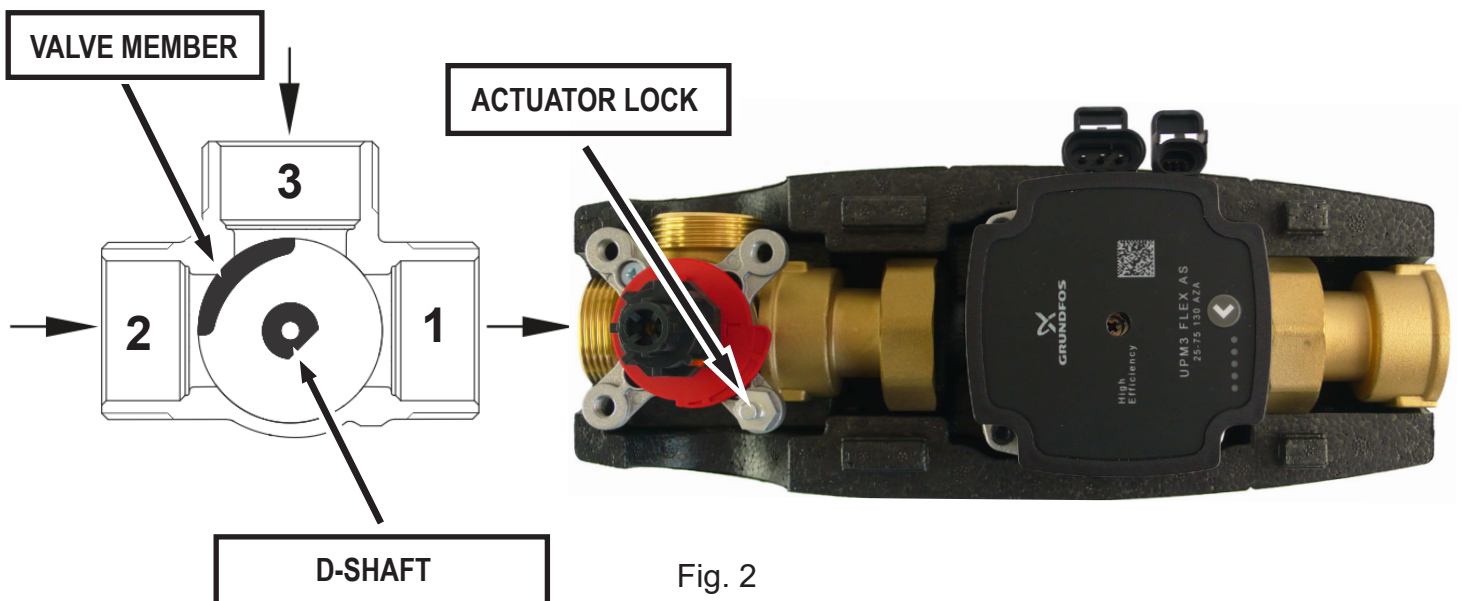
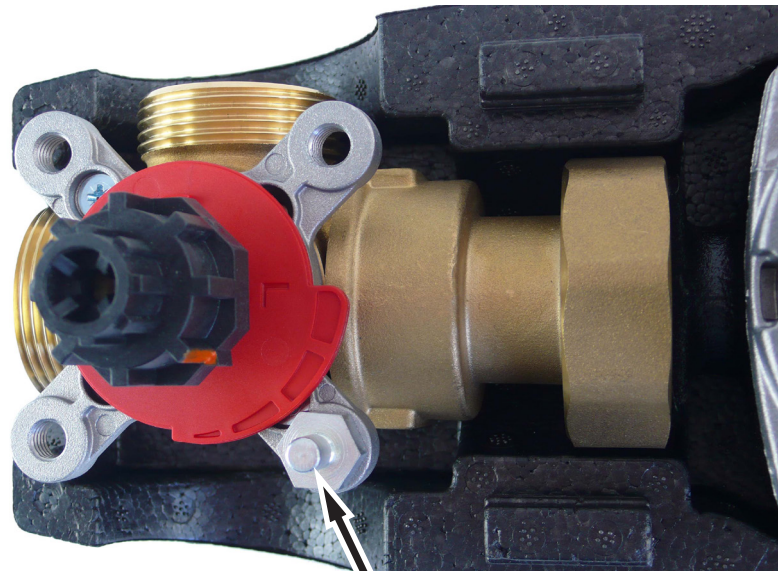

Fig. 2



ACTUATOR LOCK

Fig. 3

Actuator adjustment

Having turned the valve to the left hand position, turn the D-shaft in such a manner that the valve member is between inlets 2 and 3, turn the plastic red wheel into its proper position (see Fig. 4), and finally fit the plastic adapter (see Fig. 5).

The flat edge of the shaft and the arrow on the plastic adapter are located across from the valve member!

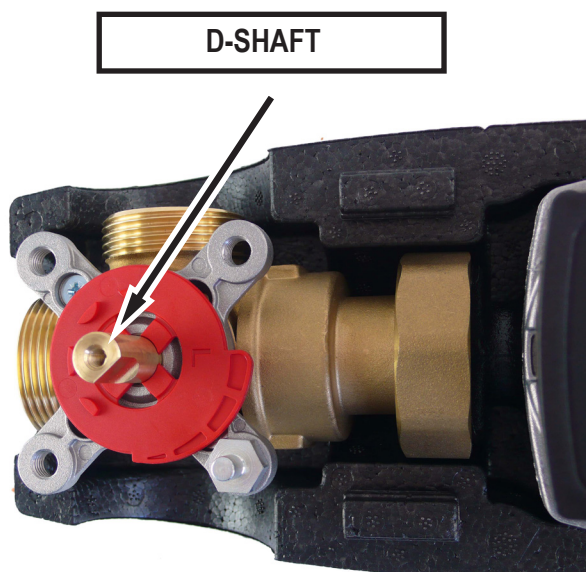

Fig. 4

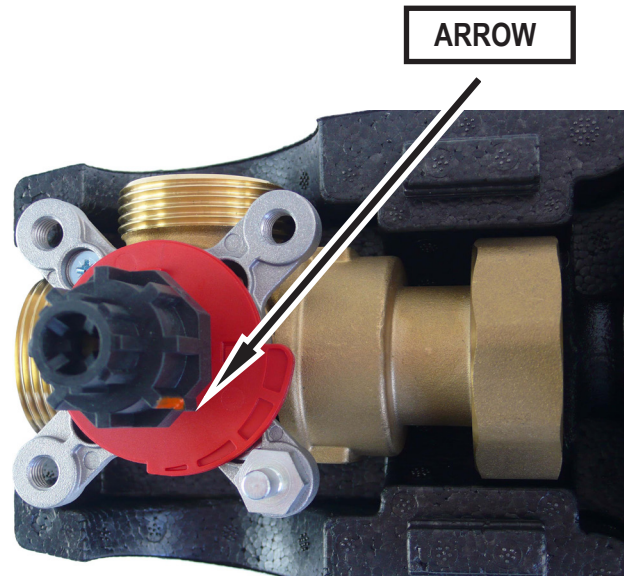
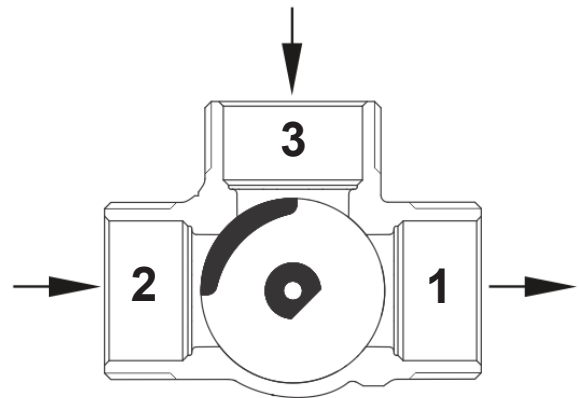

Fig. 5

Prior to fitting the actuator on the plastic adapter, switch it to manual control, set the control knob to the middle of its control range and then fit the actuator onto the adapter already on the valve. The control knob shall be able to turn freely both to left and right by 45°. When turned to the right by 45°, the path 3 is closed, and when turned to the left by 45° the path 2 is closed. Having performed the check, turn the knob back to automatic control.



After the actuator is fitted, the correct position of the round indication label (hot/cold, red/blue) shall be checked as to the right function and position of the valve.

In case of a horizontal installation on a solid fuel boiler return line, the red mark on the label shall be on the right-hand side for right-hand installations (the pump station to the right of the boiler, see Fig. 6) and on the upper side for left-hand installations (the pump station to the left of the boiler, see Fig. 7).



Fig. 6



Fig. 7

In case of a vertical installation in a heating system, the red mark on the label shall be on the right-hand side for left-hand installations (the bypass pipe of the mixing valve to the left, see Fig. 8) and on the left-hand side for right-hand installations (the bypass pipe of the mixing valve to the right, see Fig. 9).



Fig. 8

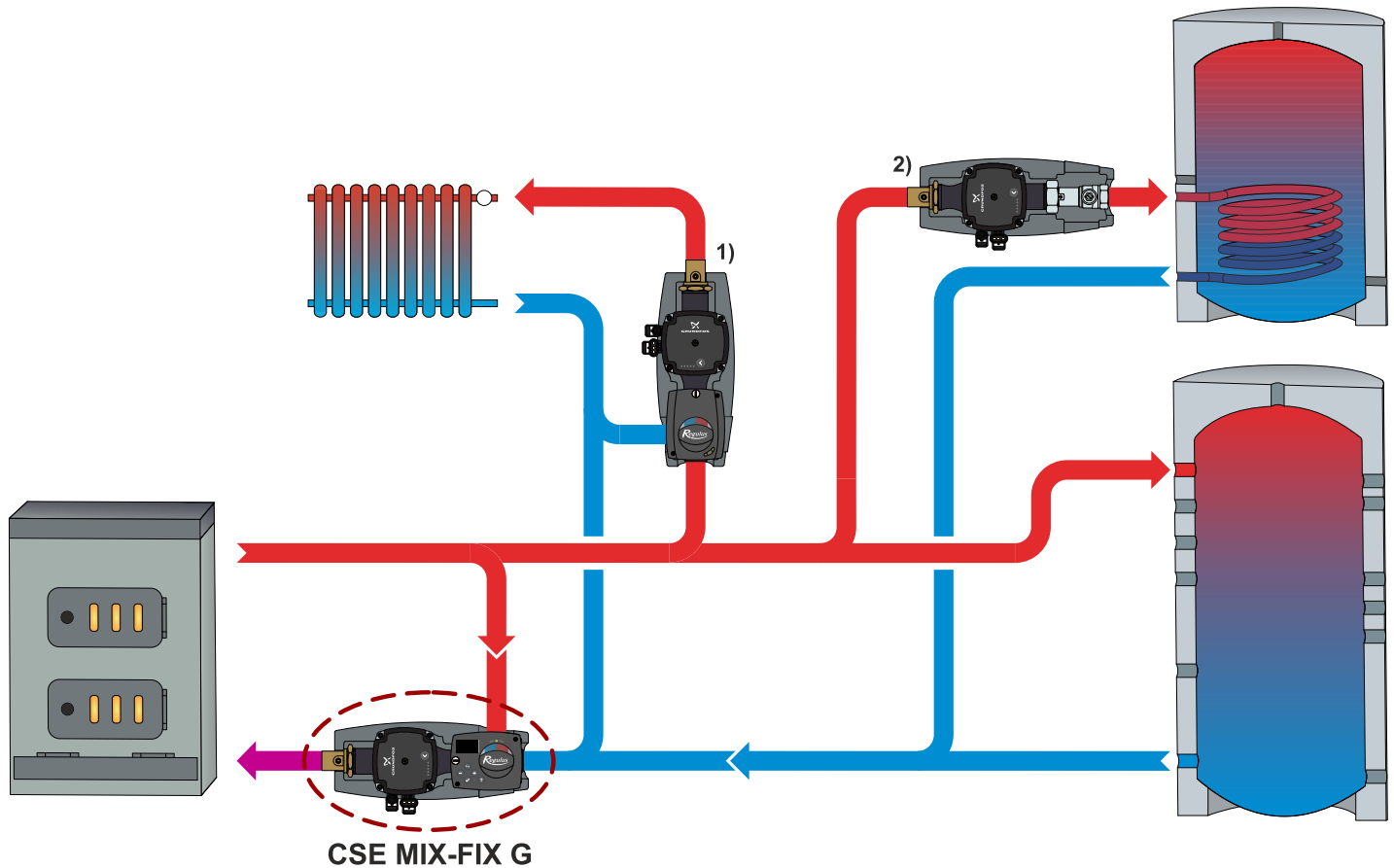

Fig. 9

4. Pump Station Connection Diagram

The pump station may be installed in either horizontal or vertical position.

CSE MIX-FIX G



- 1) CSE MIX G1F - Code 16401
- CSE MIX G1M - Code 15208
- CSE MIX G5/4F - Code 16402
- CSE MIX G5/4M - Code 16847
- 2) CSE OTS ZV G - Code 15042

5. LK Mixing Valve

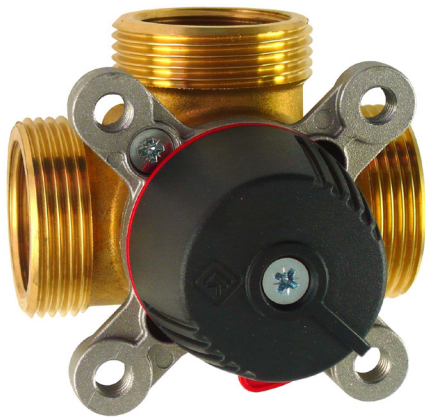

Technical data	
Working temperature	5 - 110 °C (120 °C in short term)
Max. working pressure	10 bar
Ambient working temperature	5 - 60 °C
Valve K_{vs}	12 m ³ /h
Max. pressure difference	5 m H ₂ O
Leakage rate	< 1% K_{vs} at 5 m H ₂ O pressure difference
Connections	3 x G 5/4" M

Materials	
Valve housing, spindle, member	brass
Seal	EPDM

Valve pressure drop graph

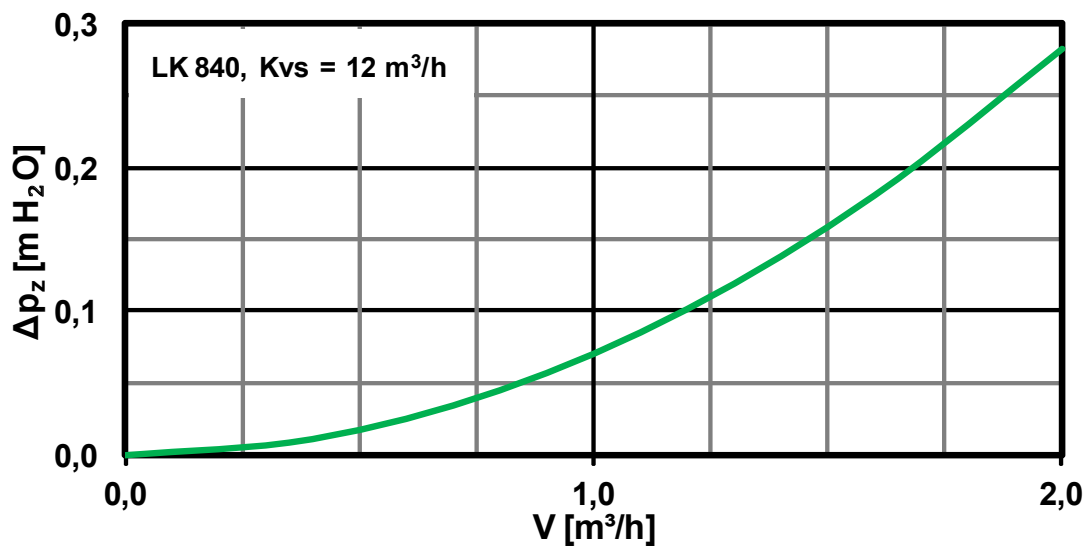

6. Mixing Valve Actuator

For adjustments to the actuator, see its Instruction Manual (included in the supply).



Technical data	
Torque	6 Nm
Angle of rotation	90°
Shift time	120 s
Control	constant temperature
Auxiliary switch	none
Power supply	230 V AC
Max. power input	3.5 VA
IP rating	IP42
Protection class	I by EN 60730-1
Ambient temperature	5 - 40 °C
Cable (cross section area - length)	3 x 0.5 mm ² - 2 m, type E
Temperature sensors	2 x Pt1000

Actuator installation and sensors connection

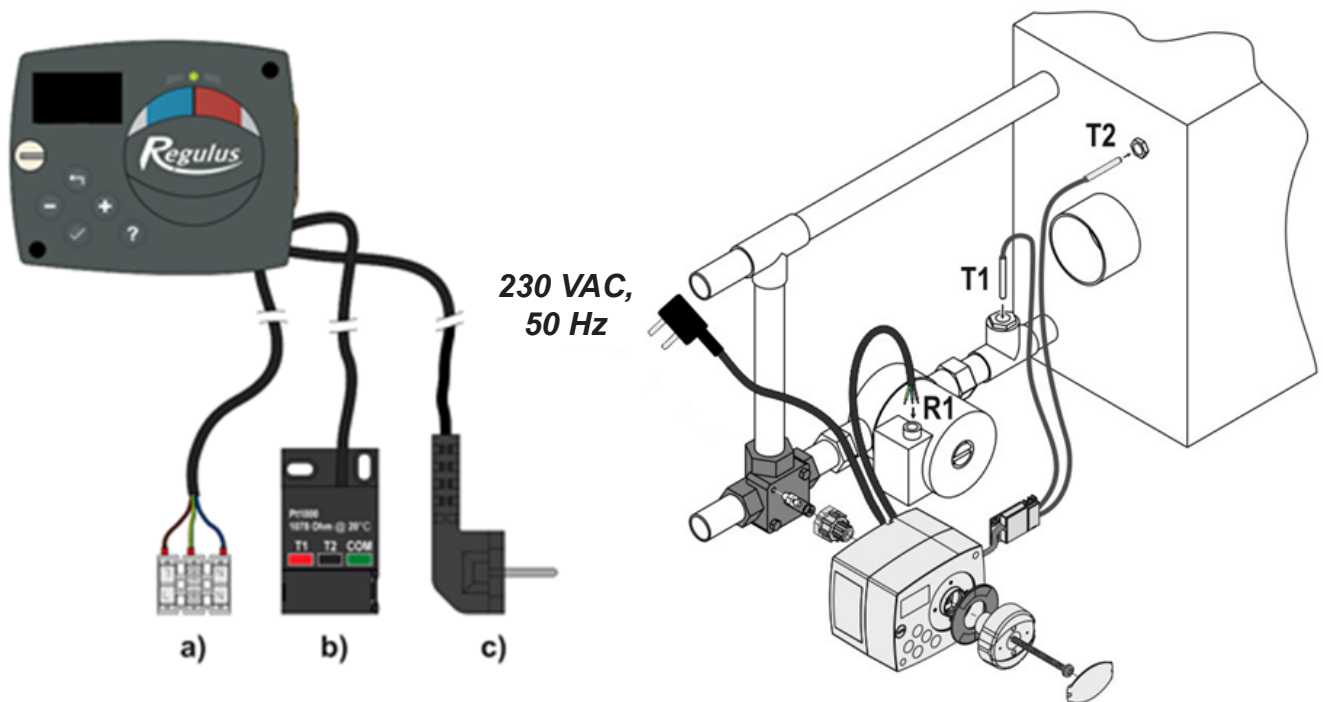

- a) connection for circulation pump switching on/off (R1)
- b) Pt1000 temperature sensors connection (T1, T2)
- c) 230 V AC, 50 Hz power supply

7. UPM3 FLEX AS 25-75 130 mm Pump

Design

Wet-running circulation pump with G 6/4" M connection.

Electrical data	
Power supply	230 V, 50 Hz
Power input (min./max.)	2/60 W
Current (min./max.)	0.04/0.58 A
IP rating	IP44
Max. speed	5991 rpm
Weighted average power	≤ 28 W
Energy Efficiency Index	≤ 0,20 by EN 16 297/3
Motor protection	not needed

Minimum pressure at the suction port	
Min. pressure at the suction port to avoid cavitation	0.05 bar at 75 °C
	0.50 bar at 95 °C
	1.08 bar at 110 °C



Pump control

The circulation pump can be controlled by an external PWM signal (profile for use in heating systems) or without a PWM signal by selecting a pump performance curve.

A maximum curve of a pump working range can be defined.

- with PWM signal the pump speed changes with the signal value up to the maximum of the selected curve
- without PWM signal the pump runs at the max. speed according to the selected curve

Performance curves

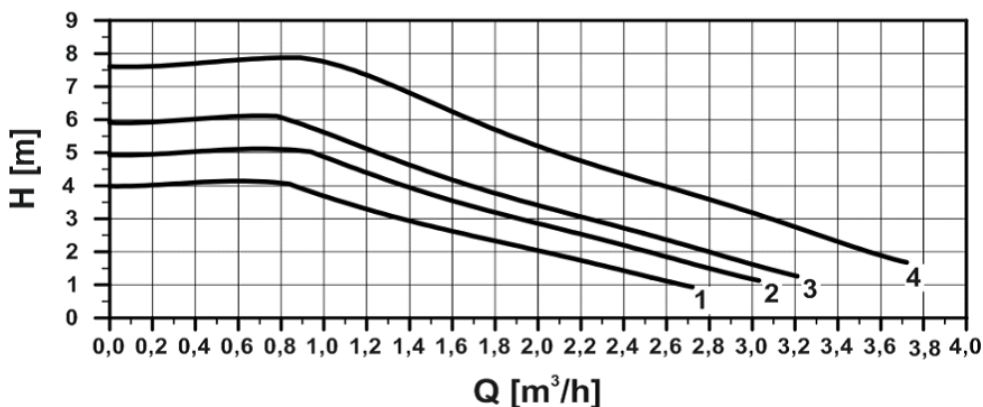

Curve	Max. H (upper graph)	Max. P ₁ (lower graph)
1	4 m	25 W
2	5 m	33 W
3	6 m	39 W
4	7.5 m	60 W

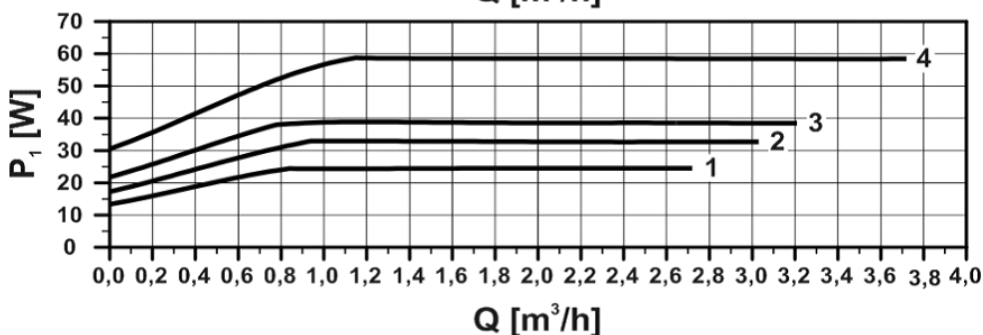

Performance display

DISPLAY	STATE	PERFORMANCE in % of $P_{1,max}$
1 flashing green LED	STAND-BY MODE (EXTERNAL CONTROL ONLY)	0
1 green + 1 yellow LEDs	LOW PERFORMANCE	0-25
1 green + 2 yellow LEDs	MEDIUM-LOW PERFORMANCE	25-50
1 green + 3 yellow LEDs	MEDIUM-HIGH PERFORMANCE	50-75
1 green + 4 yellow LEDs	HIGH PERFORMANCE	75-100

When switched on, the pump runs at factory settings or the last setting. The display shows the momentary pump performance.

Settings display

WARNING: LEDs may be turned by 180°, depending on the specific pump type.

By pressing the button the display switches to “performance view” and the current settings will be shown by LEDs for 2 seconds (see figures below).



Error display

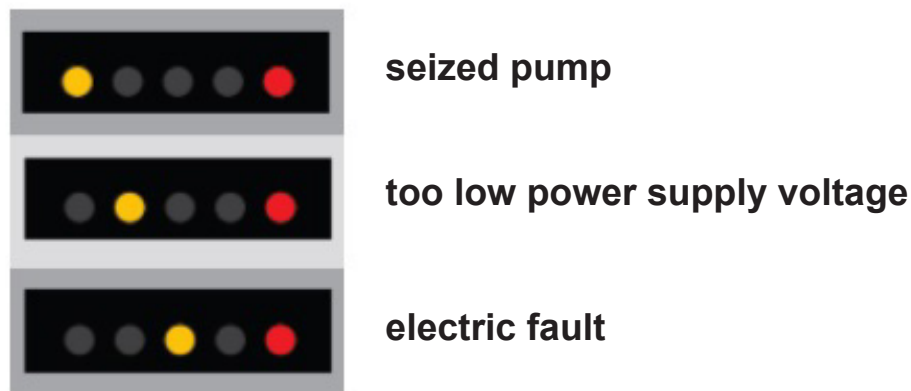

Setting selection for UPM3

1. Press the pushbutton until the LEDs start flashing, the pump will switch to adjustment selection mode.
2. To select your desired setting, press the button repeatedly until you find the setting you need (see the figures below). If you pass the desired setting, you have to go one more round until it appears again – there is no way back in the loop.



3. Release the button for more than 10 s and the LEDs will return to „performance view“, while the last setting is saved.

Forbidden pump positions

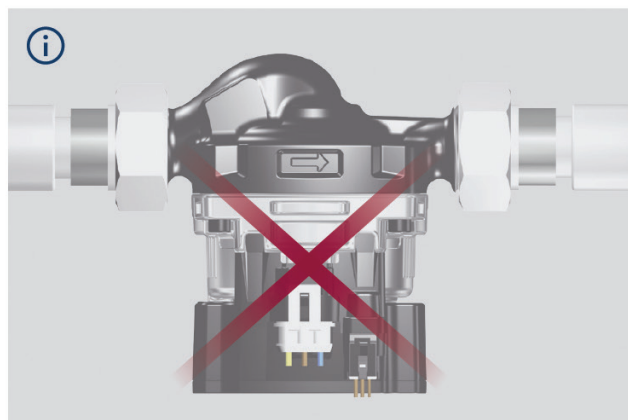
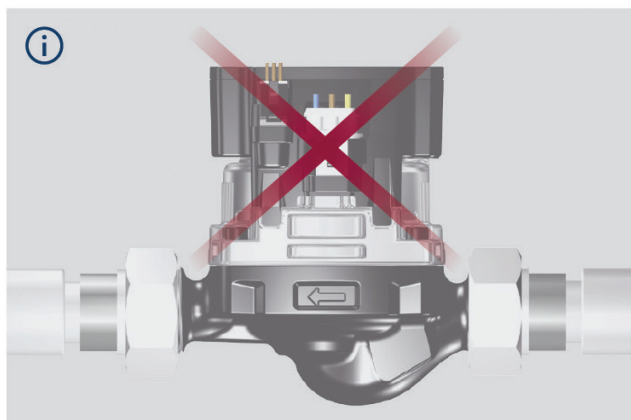

Permissible pump (actuator) positions

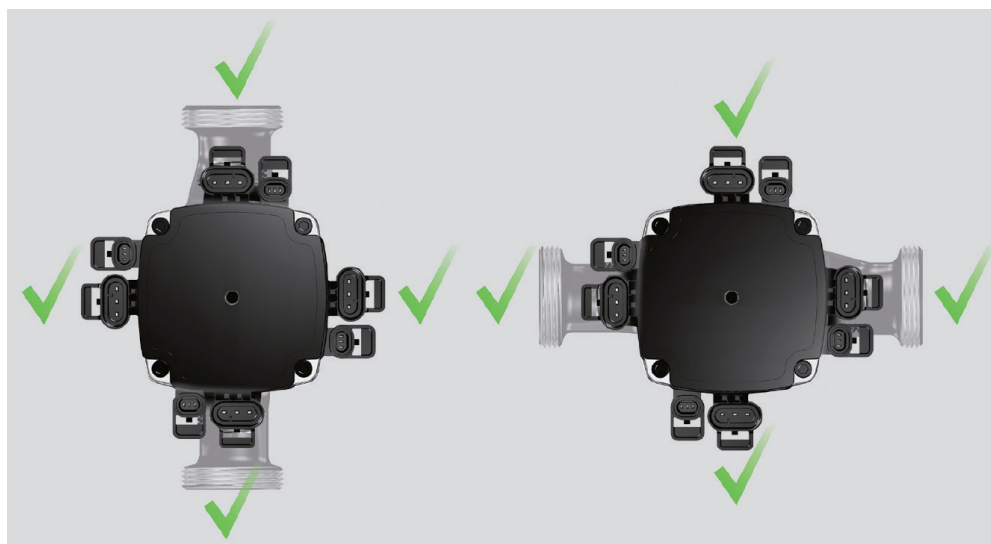

Pump wiring

