



www.regulus.eu



CSE2 SOL G SRS1T P

Installation and Operation Manual
CSE2 SOL G SRS1T P SOLAR PUMP STATION

EN

CSE2 SOL G SRS1T P

1. Introduction

This twin-line solar pump station contains all components necessary for current and efficient operation. It is designed for operation with one solar consumer (e.g. hot water tank). An auxiliary electric heating element of 2–3 kW output or a gas boiler (or another switched heat source) can be connected with the pump station. Switching ON/OFF the heat source is controlled by a heating controller. The heat source must be connected to a potential-free switching contact of the controller (max. 3 kW) and must be controlled by the additional temperature sensor S3. A heating element, safety temperature limiter of the switched heat source and the S3 sensor are not included in the scope of supply.

2. Pump Station Description

Main features	
Description	<p>The pump station includes:</p> <ul style="list-style-type: none"> ● UPM3 Hybrid 25-70 circulation pump, ● SRS1 T controller, ● check valve, ● safety valve with G 3/4" F outlet, ● ball valve on the supply line, 2 ball valves on the return line, ● air eliminator with manual air vent valve, ● flowrate indicator, ● pressure gauge, ● thermometers on both flow and return lines, ● two G 3/4" M valves for filling, draining and topping up the solar thermal system, ● G 3/4" M outlet for connecting an expansion vessel, ● already connected temperature sensor of a solar consumer (4 m long), ● already connected cable w. silicone insulation to connect a solar sensor (1 m long), ● solar temperature sensor (2 m long cable), ● already connected 230 V power cord with plug (3 m long, 3 x 1.5 mm² cross section), ● mounting kit for installation on a wall or tank, ● insulation.
Installation	On a tank or wall.
Working fluid	Water–glycol mixture (max. 1:1)

Codes corresponding to connection sizes

Connection	G 3/4" M	G 1" M
Flow measurement range	2-12 l/min	8-28 l/min
Code	20581	20577

3. Pump Station Data

Data for CSE2 SOL G SRS1 T P Pump Station	
Max. fluid working temperature	110 °C
Max. working pressure	6 bar
Min. system pressure	1.3 bar with the pump stopped
Max. switching current	13 A / 230 V
Power supply	230 V, 50 Hz
IP rating	IP20
Ambient temperature	5 - 40 °C
Max. relative humidity	85% at 25 °C
Insulation material	EPP RG 60 g/l
Dimensions (w x h x d)	405 x 490 x 155 mm
Total weight	6,8 kg

Min. values of working pressure*

Values of min. working pressure at the pump suction port depending on temperature	0.8 bar at 50 °C 1.2 bar at 90 °C 1.8 bar at 110 °C
---	---

** this condition is met for current installations when the initial system pressure is set following the formula (see the Instructions for solar collectors): $p = 1,3 + 0,1 \cdot h$ [bar], where $h...$ is the height from pressure gauge to the middle of collector array [m].

Pump Station Internal Wiring

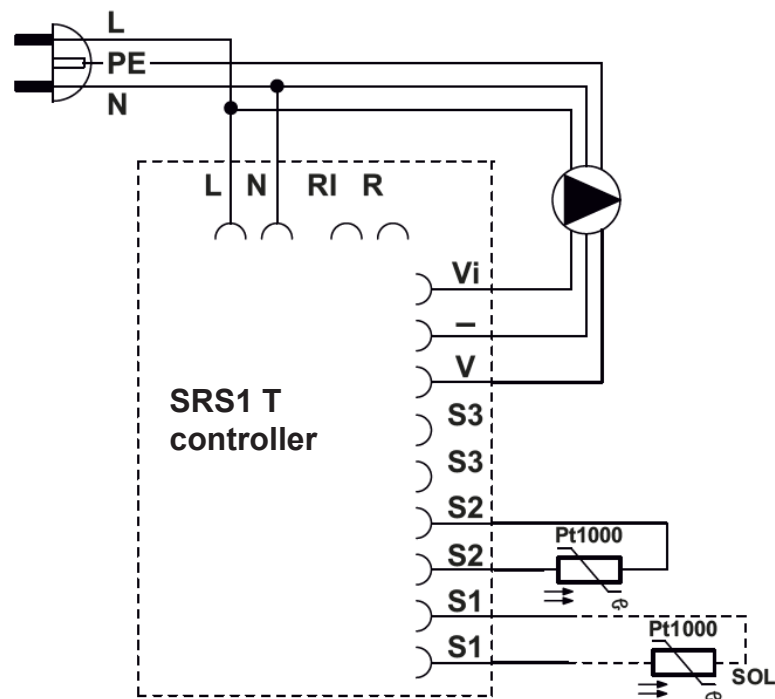

- L live
- N neutral
- RI, R potential-free switching contact
- Vi iPWM signal input
- GND PWM
- V PWM signal output
- S2 sensor 2 (solar consumer)
- S1 sensor 1 (collector)

Sensor S3 is not included. When using the solar pump station in cases where the S3 sensor is required (see diagrams 1, 2 and 3 in chapter 7.3), it must be ordered (order code 9109) and connected according to the instructions for the SRS1 T controller.

Temperature vs. Resistance Table for Pt1000 Sensors

°C	0	10	20	30	40	50	60	70	80	90	100
Ω	1000	1039	1077	1116	1155	1194	1232	1270	1308	1347	1385

3.1 Pressure Drop Graph

Connections G 3/4" M – code 20581

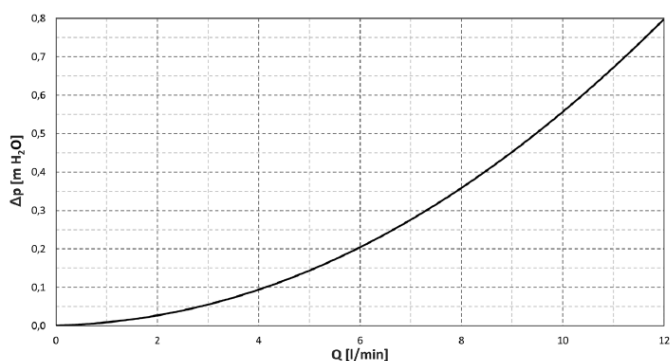

Connections G 1" M – code 20577

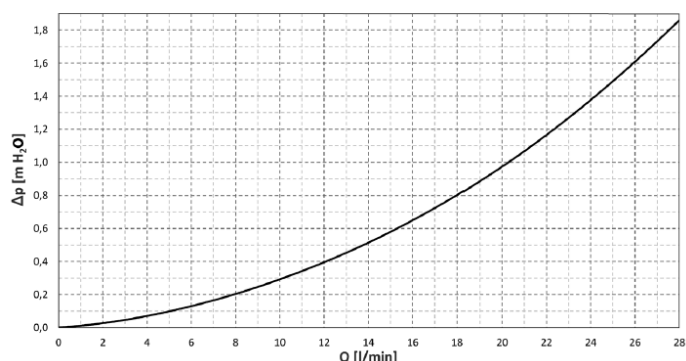

4. Pump Station Components

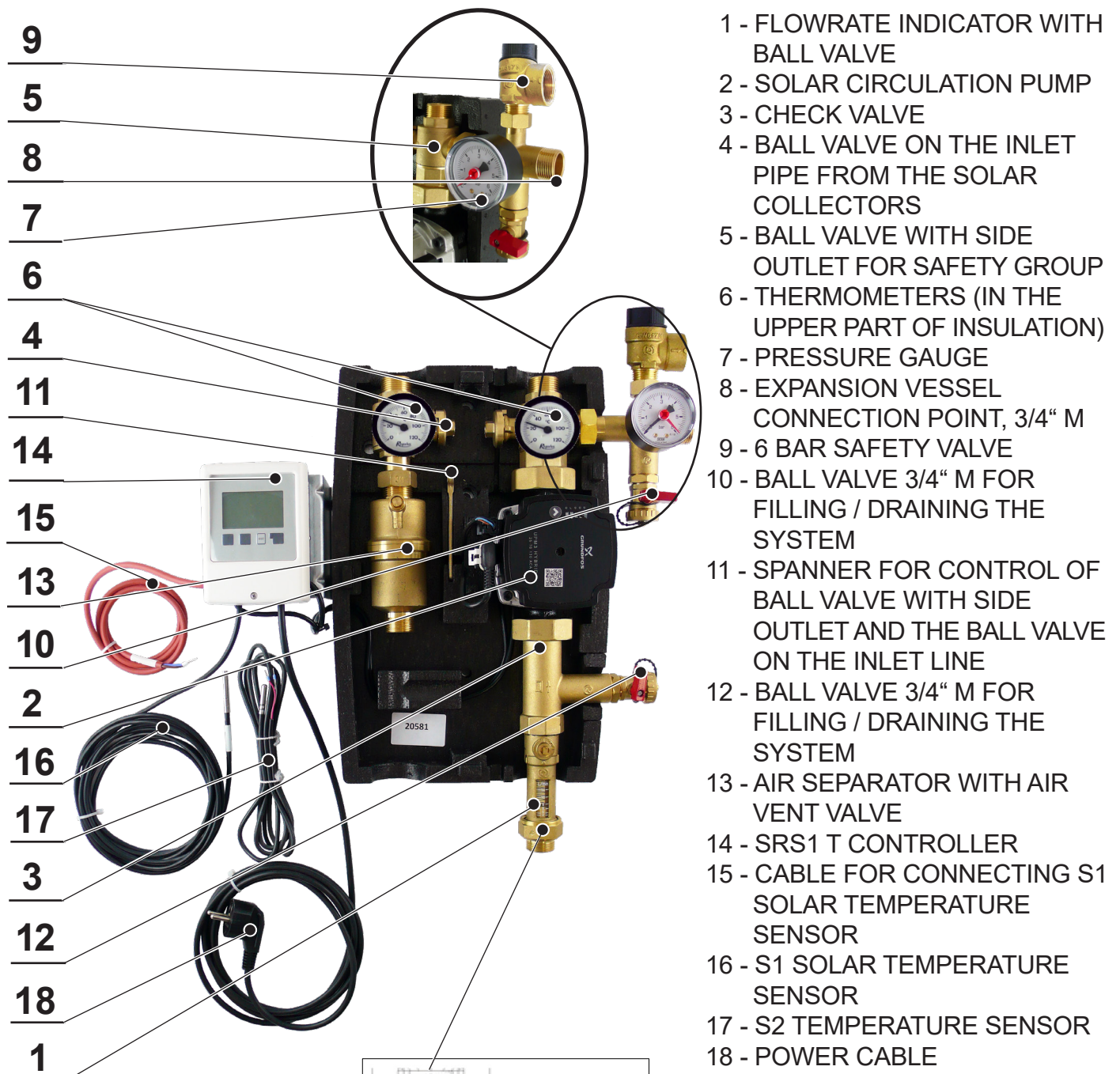

- 1 - FLOWRATE INDICATOR WITH BALL VALVE
- 2 - SOLAR CIRCULATION PUMP
- 3 - CHECK VALVE
- 4 - BALL VALVE ON THE INLET PIPE FROM THE SOLAR COLLECTORS
- 5 - BALL VALVE WITH SIDE OUTLET FOR SAFETY GROUP
- 6 - THERMOMETERS (IN THE UPPER PART OF INSULATION)
- 7 - PRESSURE GAUGE
- 8 - EXPANSION VESSEL CONNECTION POINT, 3/4" M
- 9 - 6 BAR SAFETY VALVE
- 10 - BALL VALVE 3/4" M FOR FILLING / DRAINING THE SYSTEM
- 11 - SPANNER FOR CONTROL OF BALL VALVE WITH SIDE OUTLET AND THE BALL VALVE ON THE INLET LINE
- 12 - BALL VALVE 3/4" M FOR FILLING / DRAINING THE SYSTEM
- 13 - AIR SEPARATOR WITH AIR VENT VALVE
- 14 - SRS1 T CONTROLLER
- 15 - CABLE FOR CONNECTING S1 SOLAR TEMPERATURE SENSOR
- 16 - S1 SOLAR TEMPERATURE SENSOR
- 17 - S2 TEMPERATURE SENSOR
- 18 - POWER CABLE

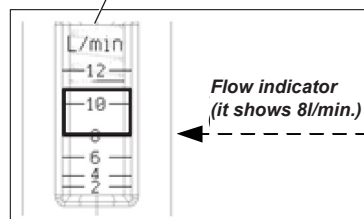

Flow indicator:
When taking a reading, the value at the bottom of the sliding indicator is valid (see picture).

4.1 Check valve

The check valve prevents the tank from cooling down due to gravity circulation when the sun is not shining. After closing the ball valves it can be removed and cleaned without having to drain the solar fluid from the entire circuit.

4.2 Ball valves

Ball valves are used to separate the pump station from the solar circuit. During servicing (including cleaning of the check valve) there is no need to drain the fluid from the solar system. For greater rigidity of the hydraulic part of the pump station, the upper ball valves are attached to the fixing back plate. The upper ball valves are operated by a lever which is not located on the valve during operation. A wrench or pliers must be used to operate the lower ball valve, which is part of the flow indicator. Turning the lever or the key or pliers a quarter turn to the right closes the ball valve. It opens when the lever is turned to the left. Before closing / opening the ball valve, it is necessary to remove the top part of the insulation. As a result, closing the system is reserved for installation or service technicians only. Thus, the user cannot simply close the solar circuit and cause stagnation and subsequent degradation of the solar fluid.

The ball valves are equipped with a spindle packing with two O-rings with dimensions of 8.7x1.8 mm that can be easily replaced by removing the control element with stop ends and loosening the packing nut with a # 21 spanner.

WARNING! IMPORTANT!

The safety relief valve, expansion vessel and upper filling valve always remain connected with the solar thermal system, even when the ball valves are shut off! Never try to isolate them from a filled solar thermal system as there is a risk of serious injury and damage to the system!

Never close the safety valve discharge piping, it shall remain free for fluid eventually discharged by the safety valve!

5. Air Separator with Air Vent Valve

In order to remove air from the circuit perfectly, the pump station is equipped with a so-called air separator with an air vent valve. After filling or topping up the fluid in the circuit and during the pre-season check, it is always recommended to release the air using the air vent valve



6. Installation options

The solar pump station is designed to be mounted on a wall or a tank. In the rear section of the insulation there are three mounting holes. The two upper holes are intended for installation on a wall using the mounting kit included in supply. The two lower holes are intended for installation on a tank (160 mm pitch) using the mounting kit included in supply. When mounting the pump station on a tank, use large washers between the tank and pump station for both the holes; the third washer shall be used for the lowest hole between the bolt head (M6x25) and the pump station. The washers are included in supply.

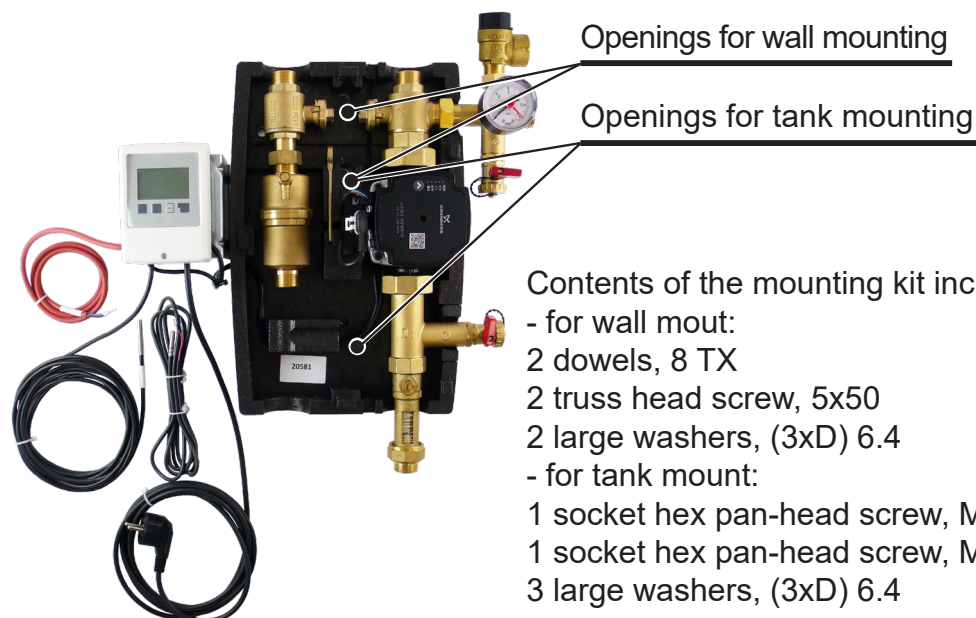

Contents of the mounting kit included in supply:

- for wall mount:

2 dowels, 8 TX

2 truss head screw, 5x50

2 large washers, (3xD) 6.4

- for tank mount:

1 socket hex pan-head screw, M6x16 (middle hole)

1 socket hex pan-head screw, M6x25 (lower hole)

3 large washers, (3xD) 6.4

7. Pump Station Connection Diagram

7.1 Variant with el. heating element

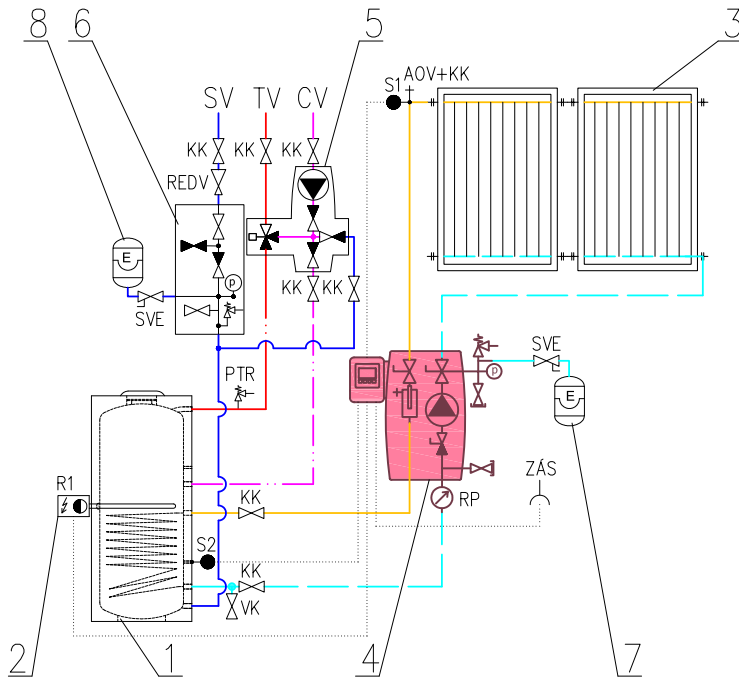

KEY

- 1 – hot water storage tank
- 2 – electric heating element with thermostat
- 3 – solar collectors
- 4 – CSE2 SOL SRS 1 T solar pump station**
- 5 – pump station for DHW recirculation – CSE TVMIX ZV
- 6 – safety kit for HW storage tank
- 7 – solar expansion vessel
- 8 – DHW expansion vessel
- SV – cold water
- TV – hot water
- CV – hot water recirculation
- KK – ball valve
- RP – flowrate indicator
- AOV – automatic air vent valve
- PTR – pressure temperature relief valve
- REDV – pressure reducing valve (optional)
- VK – drain valve
- SVE – expansion vessel service valve
- ZAS – 230 VAC, 50 Hz power socket
- S1 – Pt1000 temperature sensor for collector (connected)
- S2 – Pt1000 temperature sensor for HW storage tank (connected)
- R – SRS 1 T relay R1 (potential-free) - supply phase
- R1 – SRS 1 T relay R1 (potential-free) - switched contact
- V1 – SOL circulation pump with PWM (connected)

SRS1 T TERMINAL BOARD DETAIL

230 VAC Power supply Sensors PWM Sensors

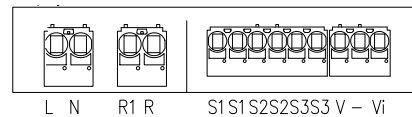

7.2 Variant with gas boiler

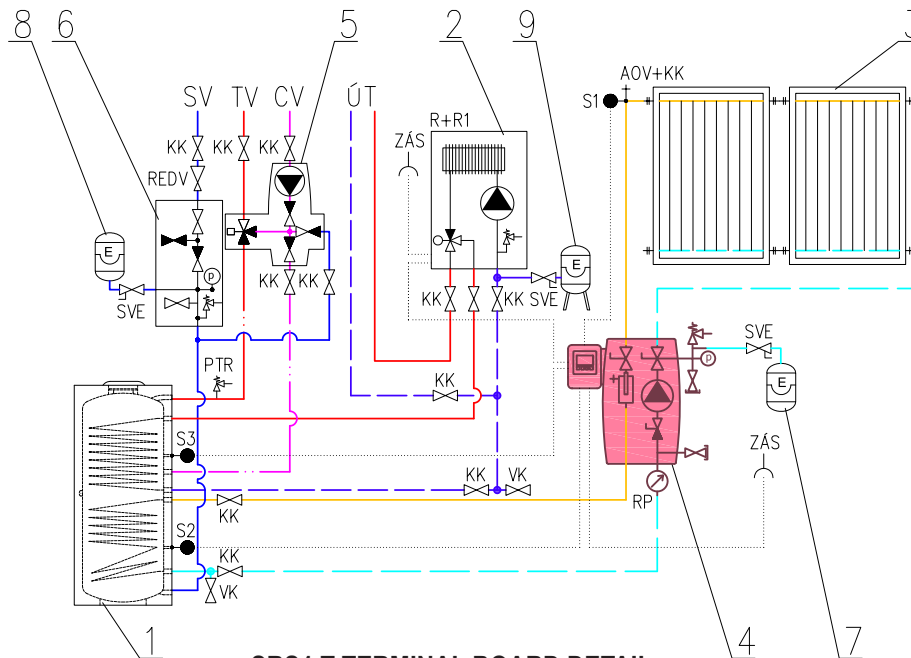

KEY

- 1 – hot water storage tank
- 2 – Boiler (el./gas... fired) controlled by potential-free contact
- 3 – solar collectors
- 4 – CSE2 SOL SRS1 T solar pump station**
- 5 – pump station for DHW recirculation
- 6 – safety kit for hot water heater
- 7 – solar expansion vessel
- 8 – DHW expansion vessel
- 9 – heating system expansion vessel
- SV – cold water
- TV – hot water
- CV – hot water recirculation
- ÚT – central heating (heating system)
- KK – ball valve
- RP – flowrate indicator
- AOV – automatic air vent valve
- PTR – pressure temperature relief valve
- REDV – pressure reducing valve (optional)
- VK – drain valve
- SVE – expansion vessel service valve
- ZAS – 230 VAC, 50 Hz power socket
- S1 – Pt1000 temperature sensor for collector (connected)
- S2 – Pt1000 lower temperature sensor for HW storage tank (connected)
- S3 – Pt1000 upper temperature sensor for HW storage tank (not connected)
- R + R1 SRS 1 T relay R1 (potential-free)
- V1 – Vi SOL circulation pump with PWM (connected)

SRS1 T TERMINAL BOARD DETAIL

230 VAC Power supply Sensors PWM Sensors

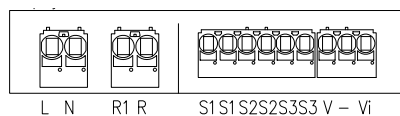

7.3 Overview of connection diagrams

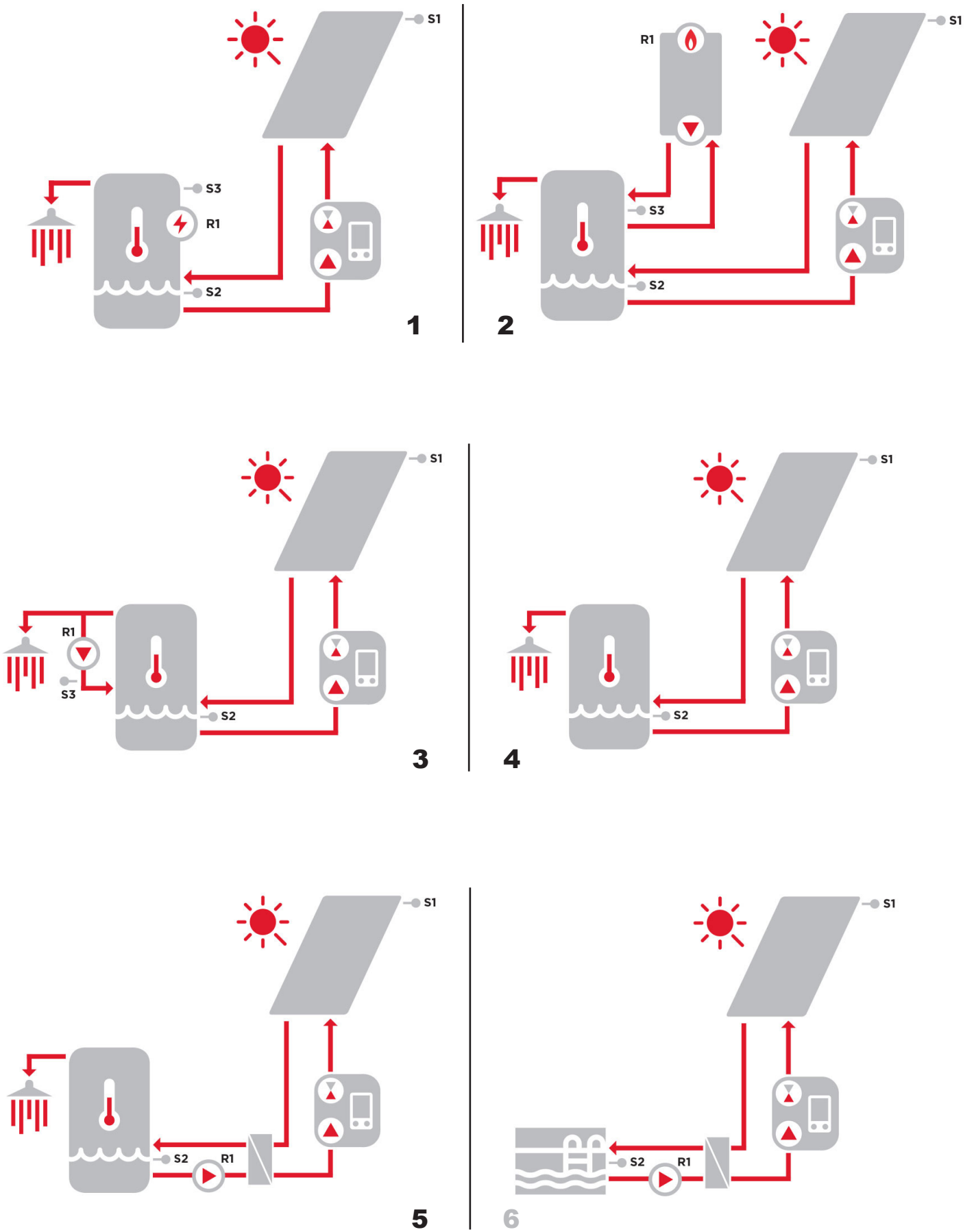

Explanation: light grey diagram number (6) – setup isn't recommended for this pump station variant

8. UPM3 HYBRID 25-70 Pump

Pump control

The circulation pump can be controlled:

- internally without PWM signal by selecting a constant pressure or constant speed mode and a desired pump curve
- externally by PWM C control signal (profile for solar systems)

WARNING – IMPORTANT

The pump permits to be controlled also by PWM A signal (profile for use in heating systems).



This mode must not be used for solar thermal systems.

Using the PWM A pump profile would cause system damage.

Using the proportional pressure mode in the internal pump control is also not advisable.

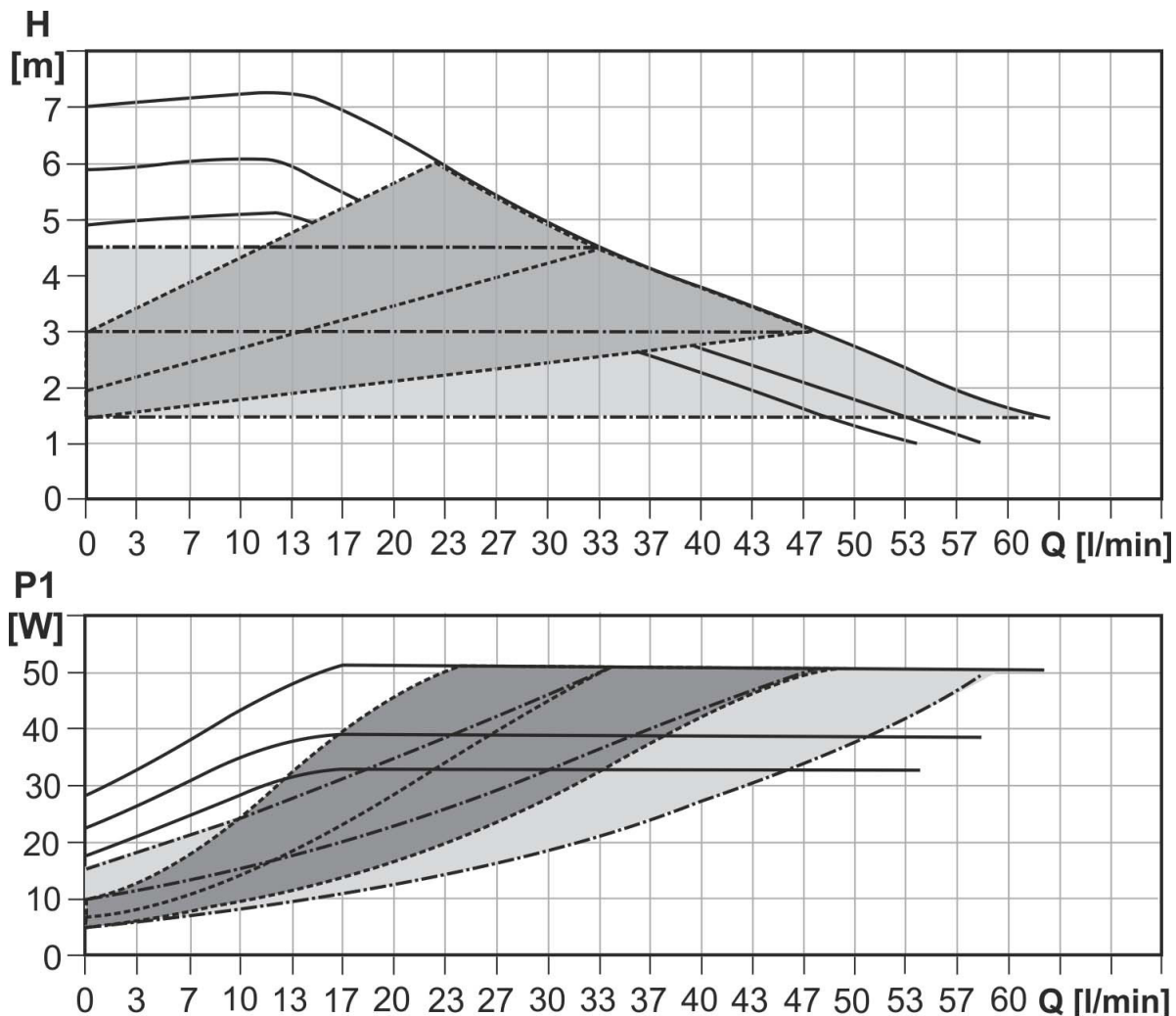
Performance curves



Line type	Description
	Constant speed
	Proportional pressure
	Constant pressure

Description of Pump Profiles

a) INTERNAL CONTROL - Proportional pressure

- Reduced with growing system pressure drop and increased with sinking system pressure drop.



- Pump operating point: moves up or down on the selected proportional pressure curve depending on the current system pressure drop.
- Using the proportional pressure mode for solar thermal systems is not advisable.

CONTROL MODE		DESCRIPTION
Proportional pressure	I	The lowest curve of proportional pressure
	II	The middle curve of proportional pressure
	III	The highest curve of proportional pressure
	AUTO _{ADAPT}	Automatically controls performance in the range from the highest to the lowest proportional pressure curve. The AUTOADAPT mode shall not be used for solar thermal systems.

b) INTERNAL CONTROL - Constant pressure

- Head (pressure): kept constant, disregarded of the system pressure drop
- Pump operating point: moves on the selected constant pressure curve depending on the current system pressure drop.



CONTROL MODE		DESCRIPTION
Constant pressure	I	The lowest curve of constant pressure
	II	The middle curve of constant pressure
	III	The highest curve of constant pressure
	AUTO _{ADAPT}	Automatically controls performance in the range from the highest to the lowest proportional pressure curve. The AUTOADAPT mode shall not be used for solar thermal systems.

c) INTERNAL CONTROL - Constant speed

- The pump runs at constant speed.



- Pump operating point: moves up or down on the selected constant curve depending on the current system pressure drop.

CONTROL MODE		Max. H (upper graph)	Max. P ₁ (lower graph)
Constant speed	I	5 m	33 W
	II	6 m	39 W
	III	7 m	52 W

d) EXTERNAL CONTROL - PWM C (solar)

- The pump runs up to the max. head following the constant speed curve set depending on the current PWM value.
- The speed will increase with the increase of the PWM value. If PWM equals 0, the pump stops.



e) EXTERNAL CONTROL - PWM A (heating)

WARNING – IT IS PROHIBITED TO USE PWM A PUMP PROFILES

Using the PWM A (I, II, III) pump profiles in a solar pump station would cause system damage.

Settings Display

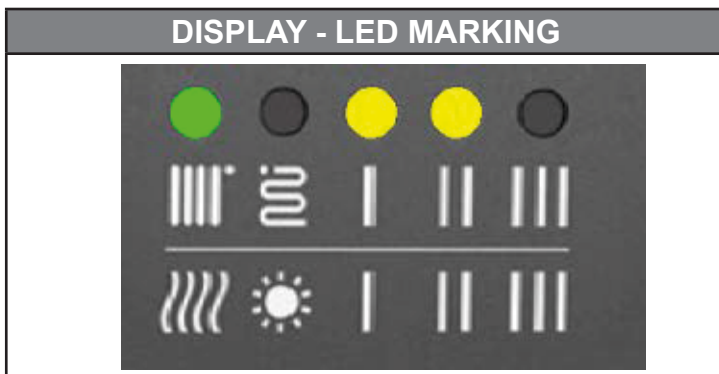

The LED marking is further omitted for better clarity.

	DISPLAY	CONTROL MODE		
	green LED NOT FLASHING	INTERNAL		
1		Proportional pressure AUTO _{ADAPT} - not used for solar thermal systems		
2		Constant pressure AUTO _{ADAPT} - not used for solar thermal systems		
3		Proportional pressure - not used for solar thermal systems	I	
4			II	
5			III	
6		Constant pressure	I	
7			II	
8			III	
9		Konstantní otáčky	I	
10			II	
11			III	

	DISPLAY	CONTROL MODE		
	green LED FLASHING	EXTERNAL		
12		PWM C		
13		PWM A	I	WARNING - DO NOT USE THESE MODES
14			II	
15			III	

GREEN LEDS FLASHING FREQUENCY	CONTROL	PWM SIGNAL RECEPTION
Not flashing	Internal	-
1 flash per second	External	NO
12 flashes per second	External	YES



WARNING: LEDs may be turned by 90° or 180°, or mirrored, depending on the specific pump type.

When switched on, the pump runs at factory settings or the last setting. The display shows the current pump performance.

Setting selection

To select your desired setting, press the button repeatedly until you find the setting you need (see the table above). If you pass the desired setting, you have to go one more round until it appears again. The order of modes corresponds to the table.

Error display

DISPLAY	CONTROL MODE
	Seized pump
	Too low power supply voltage
	Electric fault

9. Filling a Solar Thermal System

For filling a solar thermal system, the ball valve above the pump must be closed and the ball valves below the pump and on inlet pipe from the solar collectors open. The ball valves above the pump are operated by means of the enclosed spanner. Connect the filling pump to the fill and drain ball valves using hoses – see Chap. 4, and open these valves.

Prior to commissioning the system, all 3 of the ball valves must be open!

**THIS BALL VALVE MUST
BE CLOSED**

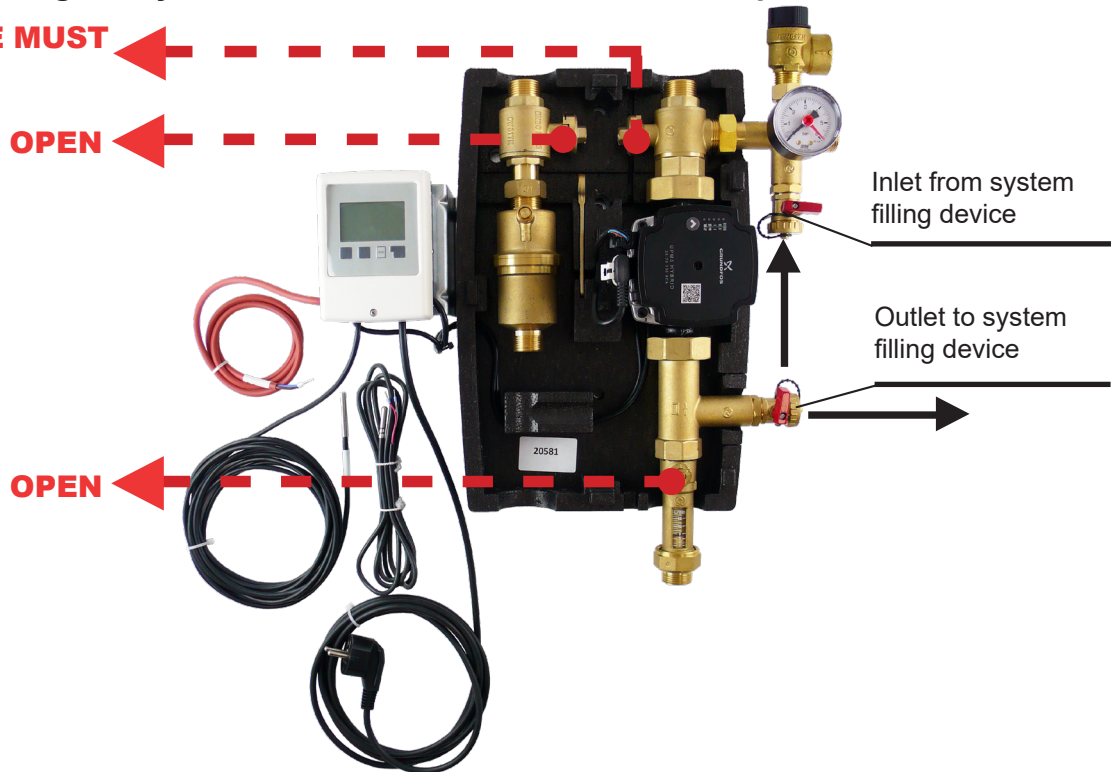

10. Solar System Air Venting

- During operation of the filling pump, close the lower drain valve and increase the pressure to about 5 bar;
- close the upper filling valve and turn off the filling pump, open the ball valve above the pump, do not disconnect the filling pump hoses!
- Set the circulation pump to the highest level in the constant speed mode and, by turning it on and off several times, vent the system using the air vent valve of the air separator and other automatic air vent valves, especially on the solar collectors and others, if they are installed in the system (the de-aerated pump works almost silently);
- continuously monitor the system pressure and if it drops, increase it to 5 bar by turning on the filling pump and opening the filling valve;
- repeat the venting until the float of the flow indicator takes a stable position during pump operation, shows a measurable flow and no bubbles appear in the sight glass. Then let the circulation pump run for at least 5 minutes;
- close the air vent valve of the air separator after air discharge is complete, and if an automatic venting valve(s) is (are) anywhere in the solar circuit, also close this valve after venting.

After filling and air venting the solar thermal system, close the fill/drain ball valve, adjust the system pressure to the required value, disconnect the hoses of the filling pump and re-open the ball valve above the pump.