

Regulus

www.regulus.eu



RGMAT E W6

Installation and Operation Manual
RegulusRGMAT E W6 LOAD UNIT
for heating systems

EN

RGMAT E W6

1. Introduction

RegulusRGMAT E W6 Load Unit makes boiler installation quicker as it contains all components needed for boiler circuit circulation and for boiler protection against low-temperature corrosion. It is designed to be installed directly on a boiler return piping. The distance of pipe axis from a wall shall be at least 100 mm to enable insulation removal if needed. This Load Unit is intended for hydronic fireplaces and solid-fuel boilers.

2. Description of the Load Unit

RGMAT E W6 keeps the temperature in a hydraulic boiler circuit above the flue gas condensation temperatures, which prevents so called low-temperature corrosion of the boiler combustion chamber. This limits condensation and boiler tarring significantly, the efficiency of fuel combustion increases and service life of the boiler is extended.

| Main Features | |
|---------------|--|
| Function | maintaining a minimum inlet temperature into a boiler (fireplace) through a load valve |
| Application | Load Unit for solid-fuel boilers and fireplaces; it prevents low-temperature corrosion and boiler (fire) fouling |
| Description | consists of Wilo PARA SC 25/6 pump, TSV3B valve (with automatic by-pass balancing), thermometer and insulation |
| Working fluid | water; water/glycol mixture (max. 1:1) or water-glycerine mixture (max. 2:1) |
| Installation | on return pipe, min. pipe centre distance from wall is 100 mm |

| Code | Max. boiler output |
|-------------------------------------|--------------------------|
| 18668 for opening temperature 45 °C | 45 kW at ΔT 20 K |
| 18680 for opening temperature 50 °C | 42 kW at ΔT 20 K |
| 18612 for opening temperature 55 °C | 36 kW at ΔT 20 K |
| 18681 for opening temperature 60 °C | 32 kW at ΔT 20 K |
| 18682 for opening temperature 65 °C | 25 kW at ΔT 20 K |
| 18683 for opening temperature 70 °C | 22 kW at ΔT 20 K |

| Data for RGMAT E W6 Load Unit | |
|-------------------------------|--------------------|
| Fluid working temperature | 5 - 95 °C |
| Max. working pressure | 6 bar |
| Min. working pressure | 0.5 bar |
| Ambient temperature | 5 - 40 °C |
| Max. rel. humidity | 80% non condensing |
| Insulation material | EPP RG 60 g/l |
| Overall dimensions | 325 x 140 x 155 mm |
| Total weight | 3.1 kg |
| Connections | 3x G 1" F |

| Accessories | |
|------------------------------|------------|
| Bypass with non-return valve | code 16126 |

3. RGMAT E W6 Connection Diagram

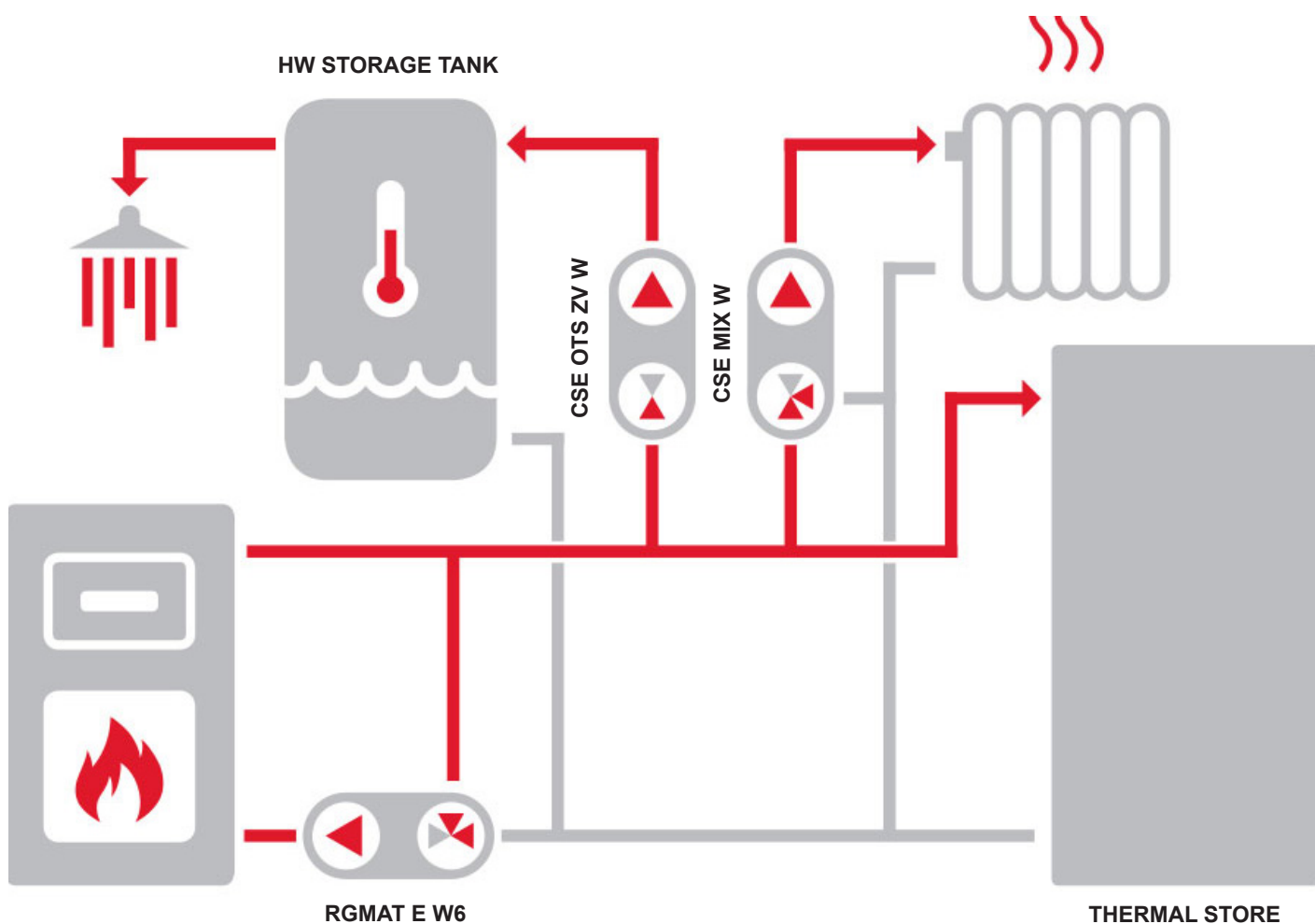

Install the Load Unit respecting the following instructions:

Connect the Load Unit outlet marked **AB** to the piping entering the boiler. Connect the return line from the heating system to the **A** inlet, and the outlet pipe from the boiler to the **B** inlet via a T-piece. Take care to install shut-off valves and filter where necessary to avoid draining the whole system for valve cleaning or replacing the thermostatic element.

When the connecting pipes are not arranged or sloped properly, the load valve may get blocked by air inside. This may hinder or even disable its operation.

Always respect valid rules and boiler manufacturer's data during installation.

4. Function Description of TSV3B Valve

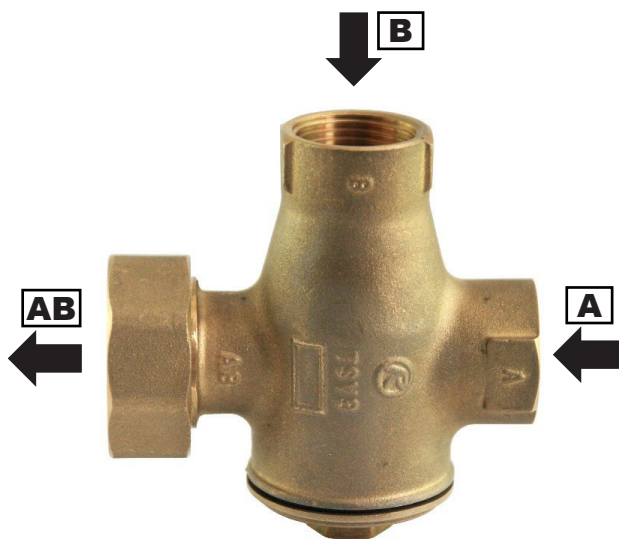

The TSV3B load valve is fitted with an integrated thermostatic insert that will close the **A** inlet (from a heating system), if the return water temperature to the boiler (**AB** outlet) is lower than the opening one. As soon as the opening temperature is reached, the thermostat starts opening the **A** inlet slowly and mixing the cold return water with the hot water from the **B** inlet (boiler flow) with the aim to reach the opening temperature (**AB** outlet) in the return pipe.

At the same time, the valve closes the **B** inlet, limiting so the hot water flow coming from the bypass till its complete tight closure. Thanks to this, no balancing valve is needed. The load valve is made of brass, element and plug seals are in EPDM, cone seal is made of NBR.

| Technical Data | |
|----------------------------|---|
| Valve opening temperature | depending on the thermostatic element |
| Control range | $t_{\text{valve opening}} + 5 \text{ }^{\circ}\text{C}$ |
| Valve Kvs (A→AB direction) | 6.2 m ³ /hod |
| Valve Kvs (B→AB direction) | 4.4 m ³ /h |
| Nominal inner diameter | DN 32 |

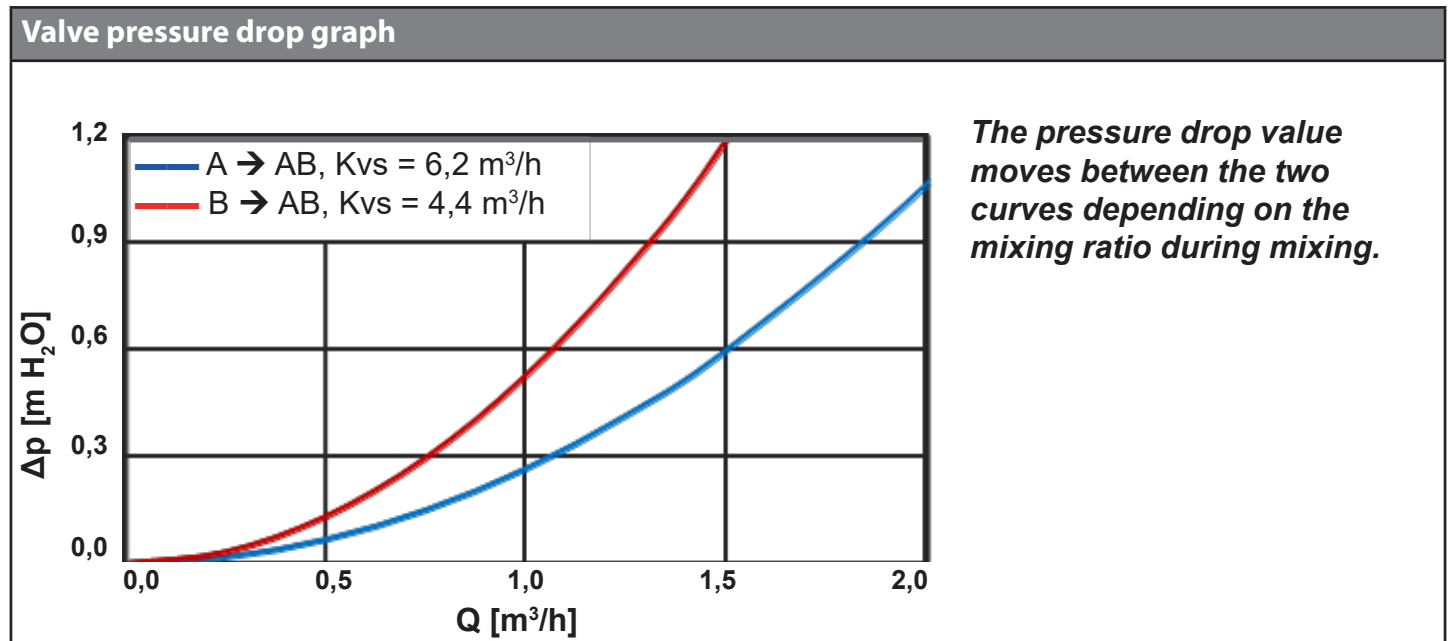

5. PARA 25/6 SC 130 mm Pump

5.1. General Information

The high efficiency circulation pumps of the PARA SC series are used exclusively for the circulation of liquids in hot water heating systems. Operating the pump in other systems or in systems lacking water, containing air or in unpressurized systems can lead to its rapid destruction.

5.2. Pump Description

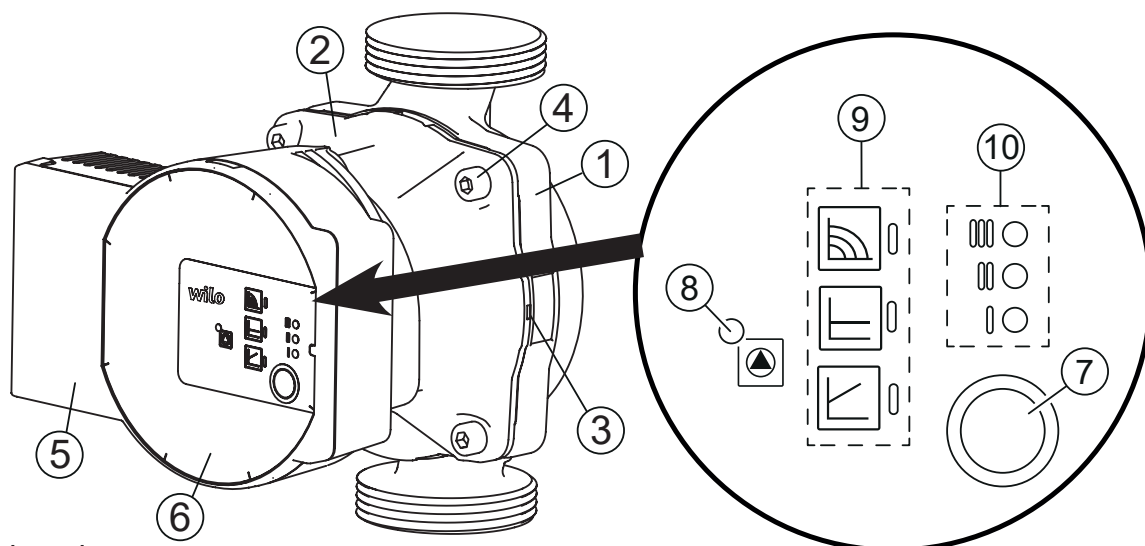

- 1 - Pump housing
- 2 - Pump motor
- 3 - Condensate drain openings
- 4 - Pump housing bolts
- 5 - Control module
- 6 - Rating plate
- 7 - Pump adjustment button
- 8 - LED indication of operation/fault
- 9 - Display of the selected pump operating mode
- 10 - Display of the selected pump curve (I, II, III)

5.3. Permitted and Prohibited Pump Positions

The pump station may be installed either horizontally or vertically.

Permitted positions



Prohibited positions

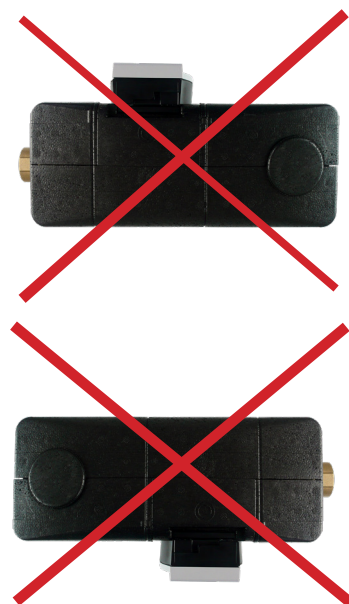

5.4. Pump Wiring

The pump shall be wired to electrical installation by a qualified person in compliance with EN 50110-1!

Plug the power cable (2) into the connector on the pump so that the connector lock (1) is in the correct position, see Fig.

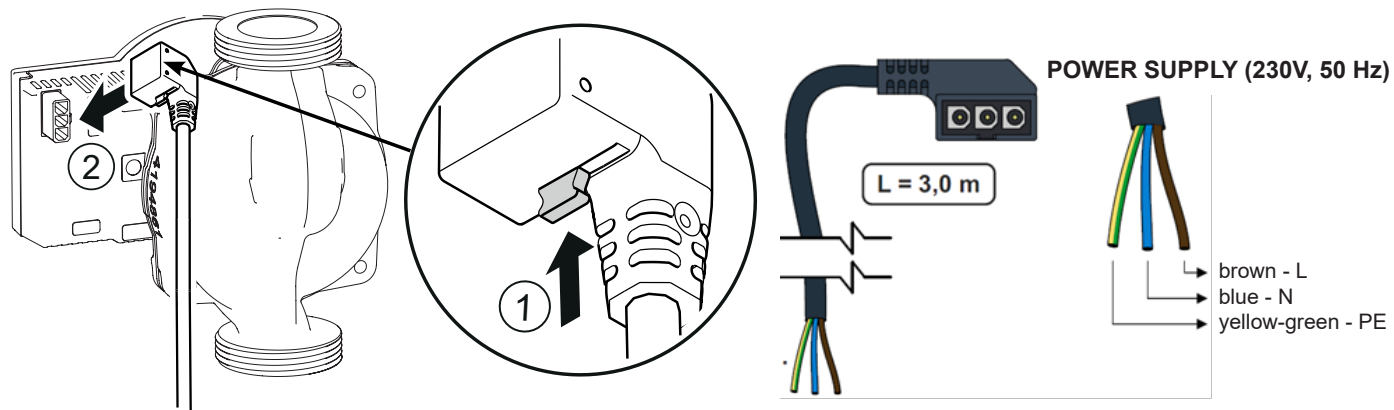

1 Lock

2 Power cable connector

5.5. Pump Control

Constant speed operating mode and pump performance curve III are preset as factory settings for the PARA SC pump. After switching on, the pump runs at the factory setting or at the last setting.

The settings can be changed using the operating button, see below.

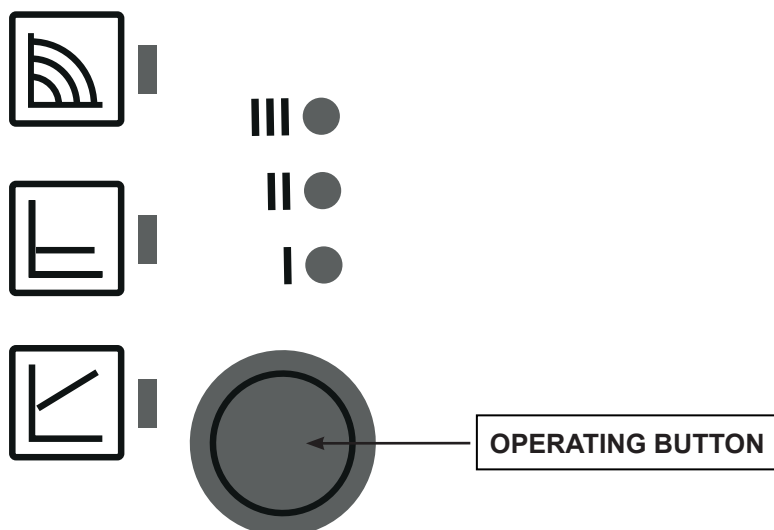

Briefly press the operating button to:







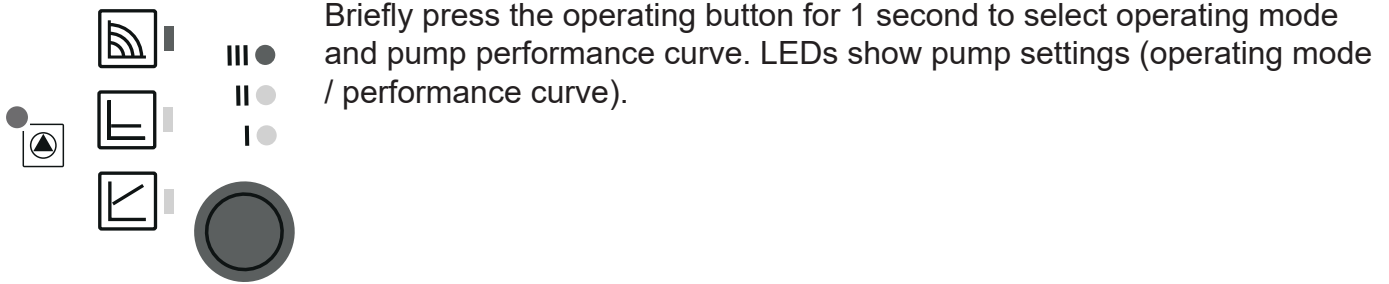

select the **pump operating mode**: constant speed, Δp -v or Δp -c and the pump **performance curve** (I, II, III)

Press and hold the operating button for the specified time to activate::

- **Pump venting function** - hold the control button for 3 seconds.
- **Manual restart** - hold the operating button for 5 seconds.
- **Locking / Unlocking the operating button** - hold the button for 8 seconds.
- **Factory setting** - hold the control button for at least 4 seconds and switch off the pump by disconnecting it from the mains.

SETTING THE PUMP PROFILE



| | LED indicators | Operating mode | Performance curve |
|---|---|------------------------|-------------------|
| 1 |  | constant speed | II |
| 2 |  | constant speed | I |
| 3 |  | Δp -v variable | III |
| 4 |  | Δp -v variable | II |
| 5 |  | Δp -v variable | I |
| 6 |  | Δp -c constant | III |
| 7 |  | Δp -c constant | II |
| 8 |  | Δp -c constant | I |
| 9 |  | constant speed | III |

PUMP VENTING

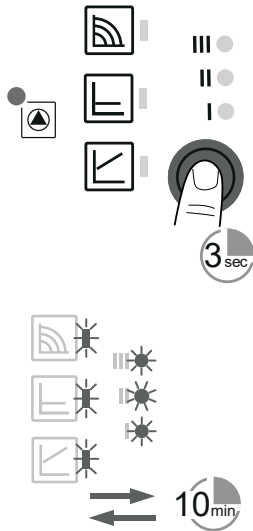

If air is present in the pump:

- o Activate the pump venting function by pressing and holding the operating button for 3 sec. The upper and lower rows of LEDs will flash in 1sec interval, see Fig.
- o Pump venting takes 10 minutes, after that the pump returns to current mode. In order to cancel pump venting, press and hold the operating button for 3 sec.

MANUAL RESTART



If the pump has been inactive for a long time or is blocked, activate the manual restart by holding the operating button for 5 seconds. The LEDs flash sequentially clockwise. The manual restart takes max. 10 minutes before the pump returns to normal operation. To cancel the manual restart, hold down the operating button for 5 seconds.

If the pump does not get unblocked, contact a qualified technician.

OPERATING BUTTON LOCKING / UNLOCKING

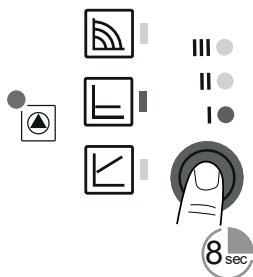

To lock the operating button, press it for 8 seconds.

The selected setting then starts flashing and cannot be changed. To unlock, hold down the operating button again for 8 seconds and the LEDs will stop flashing.



FACTORY SETTINGS

To return to the factory settings, press and hold the operating button for at least 4 sec. (all LEDs flash for 1 second) and turn off the pump by unplugging. When switched on again, the pump will run at the factory settings.

PUMP OPERATING MODES

Variable differential pressure $\Delta p-v$

It is not recommended to use variable differential pressure for solid fuel boiler pumps!

The Variable differential pressure operating mode is recommended in systems where it is advisable to reduce the discharge pressure of the pump in parallel with the decreasing required flow rate. A typical example is a heating circuit with radiators equipped with thermostatic valves, where the selection of this operating mode can reduce the noise from thermostatic valves which is caused by closing too many radiators in the system. This mode, on the other hand, is unsuitable for circuits with heat sources where the reduction of the head and flow can make these sources even inoperable.

By reducing the discharge as the flow decreases, the pump's power consumption and therefore the operating costs are significantly reduced (see graph Q-P). In larger heating circuits and in circuits where there are significant differences in heating demand in separate heating zones, this mode may temporarily cause insufficient heating. In these systems, it may be preferable to switch the pump to $\Delta p-c$ mode.

Performance curves

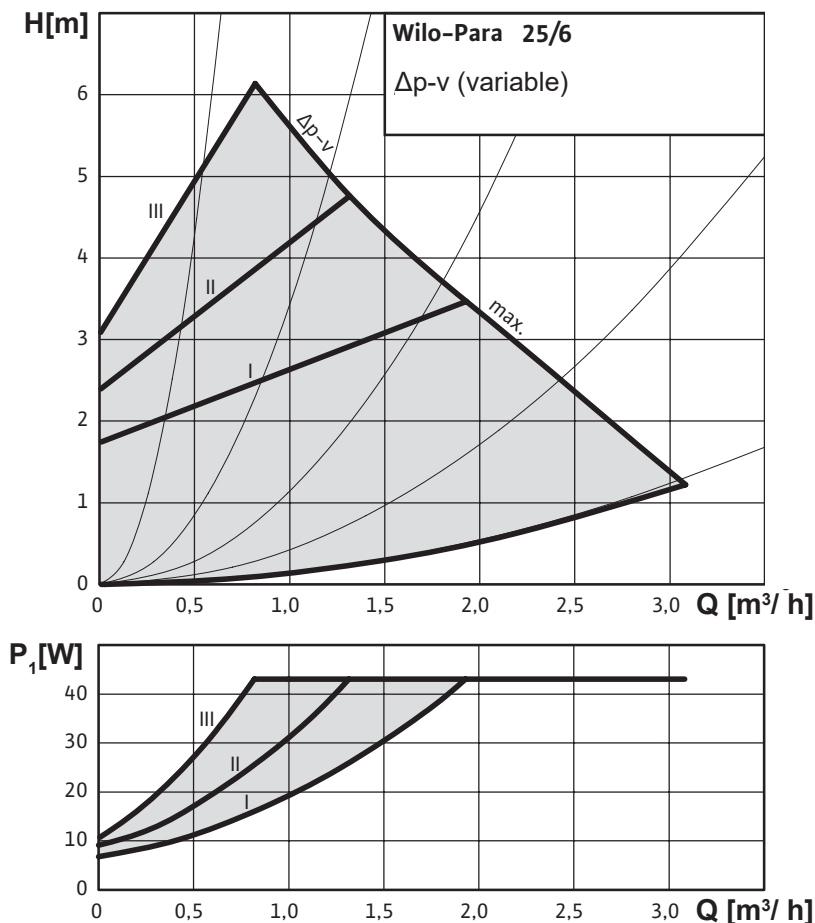

Constant differential pressure Δp -c

The Constant differential pressure (constant delivery head) operating mode is suitable for hydraulic circuits of heat sources (boilers, heat pumps, solar thermal systems etc.), hot water storage tanks, heaters, underfloor heating systems and large heating circuits where the previous mode Δp -v could cause insufficient heating through discharge reduction.

By decreasing the required flow, the pump maintains a constant delivery head, thus the pump power consumption decrease is more gentle than in the Δp -v mode.

Performance curves

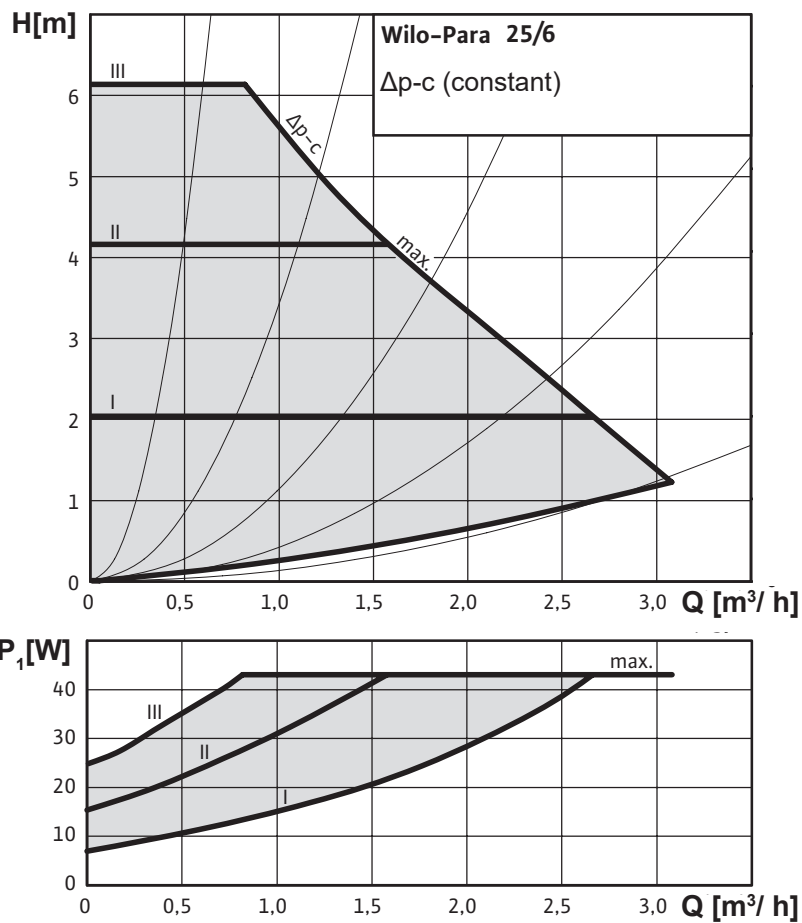



Constant speed

Constant speed operating mode means that the pump does not adjust its speed in any way depending on the flow rate or discharge of the hydraulic circuit. The flow and discharge of the pump are thus entirely dependent on the speed setting set (I, II, III) and the hydraulic circuit settings. This mode is used when the more economical Δp -c mode is not suitable. This is the same mode as in the older types of classic circulation pumps where the speed I, II, III was set by a selector switch.

For example, this mode may be suitable for older circuit types where flow is regulated by throttling and this method required to be maintained. Furthermore, it may be suitable for solid fuel boilers that are equipped with older types of TSV valves with balancing using a manual throttle valve, or in other similar specific cases of requiring a constant pump performance.

Performance curves

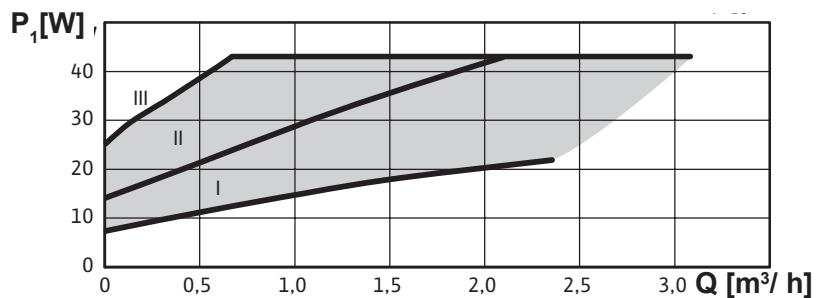
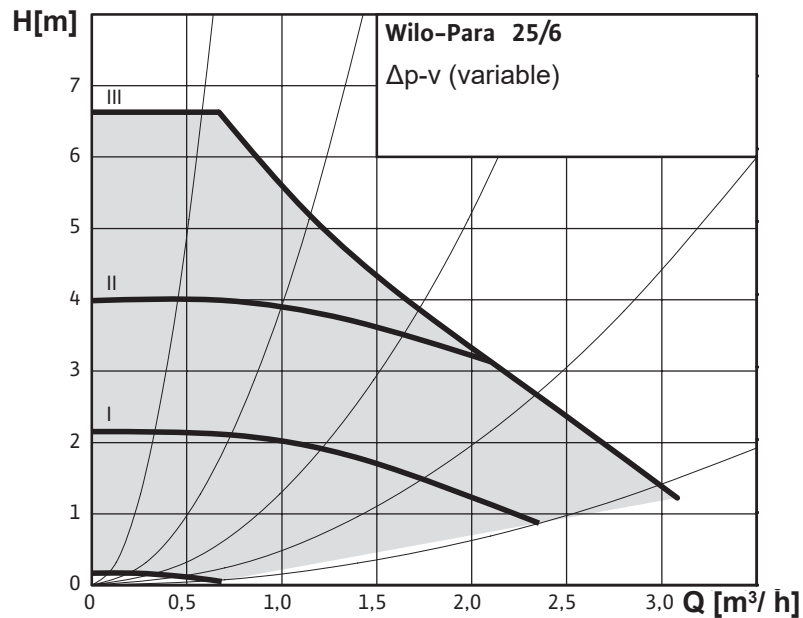





5.6. Technical Data

| Wilo PARA 25/6 SC | |
|--------------------------|-----------------------|
| Electric Data | |
| Power supply | 230 V, 50 Hz |
| Power input (min./max.) | 3 / 43 W |
| Current (min./max.) | 0.04 / 0.44 A |
| Max. speed | 4300 rpm |
| Speed control | frequency converter |
| Energy Efficiency Index | ≤ 0.21 by EN 16 297/3 |
| IP rating | IPX4D |
| Motor protection | integrated |

5.7. FAULTS, THEIR REASONS AND TROUBLESHOOTING

 The LED light signals a defect. The pump will switch off (depending on the defect type) and try to restart.

| LED indication | | state description and possible fault reasons |
|---|------------------------|---|
|  | green is lit | 1 - pump is running in trouble-free operation |
|  | red is lit | 1 - rotor is blocked 2 - electric motor winding defect |
|  | flashing red | 1 - power supply lower/higher than 230 V 2 - electric short circuit in pump 3 - pump overheated |
|  | flashing red and green | 1 - unforced fluid circulation through the pump 2 - pump speed lower than desired 3 - air in pump |

| FAULTS | REASONS | TROUBLESHOOTING |
|--|---|--|
| Pump does not run despite power supply switched on | Pump not energized | Check circuit breakers or fuses in the system control |
| Pump is making noise | Cavitation due to insufficient inlet pressure | Increase pressure in heating system within permissible range or check that circuit breaker has not tripped Check head setting, if necessary, set lower head |
| Building not warming up | Heat output of heating surfaces too low | Set higher temperature at controller and fully open radiator valves. If this does not help, increase circulation pump performance. |

If the fault cannot be rectified, contact a specialized technician.

6. Installation Options

This Load Unit comes in the version for horizontal installation to the right of a boiler. However, it can be installed also into vertical piping or horizontally to the left of a boiler. When being installed horizontally to the left of a boiler, the Load Unit needs to be turned by 180° and the TSV3 valve turned as shown in the pics below.

