



# 1. Introduction

CSE MIX W6-SC 1M pump station is designed to be installed in heating circuits where it provides heating water mixing and circulation through the circuit. Its typical application is in mixed heating circuits in buildings where it provides circulation and mixing of heating water to a desired temperature, or for solid-fuel boiler circuits where it provides circulation and mixing to a min. heating water temperature as a protection against low-temperature corrosion. Actuator of the mixing valve is controlled by an external controller through 3-point control with 230V outputs. The circulation pump is switched by an external controller with a 230 VAC output. The controller is not included in supply.

The pump station is designed to be installed directly on the pipe, with 100 mm min. distance of the pipe axis from a wall.

## 2. Description of the pump station

The pump station consists of a Wilo PARA 25/6 SC pump including a power cable, a 3-way mixing valve with actuator incl. a power cable, a ball valve and insulation.

Main Features	
Application	control of return temperature for solid-fuel boilers or control of flow to a mixed circuit by an external controller
Description	consists of a WILO PARA 25/6 SC pump, a 3-way mixing valve LK 840 with AVC actuator and insulation
Working fluid	water; water/glycol mixture (max. 1:1) or water-glycerine mixture (max. 2:1)
Installation	flow pipe into a heating circuit / return pipe of a solid fuel boiler, the min. distance of the pipe axis from a wall is 100 mm
Code	<b>18730</b>

Data for CSE MIX W6-SC 1M Pump Station	
Fluid working temperature	5 - 95 °C
Max. working pressure	10 bar
Min. working pressure	0.5 bar
Ambient temperature	5 - 40 °C
Max. rel. humidity	80 % non condensing
Insulation material	EPP RG 60 g/l
Valve Kvs	6.3 m <sup>3</sup> /h
Leak rate	< 1% Kvs at 5 mH <sub>2</sub> O pressure difference (at mixing valve inlets)
Max. pressure difference	5 m H <sub>2</sub> O (at mixing valve inlets)
Overall dimensions	305 x 135 x 195 mm
Total weight	3.9 kg
Connections	2 x G 1" M (směšovací ventil); 1 x G 1" F (pump)

### 3. Pump Station Connection

The pump station may be installed either horizontally or vertically.

#### Example of possible connection I

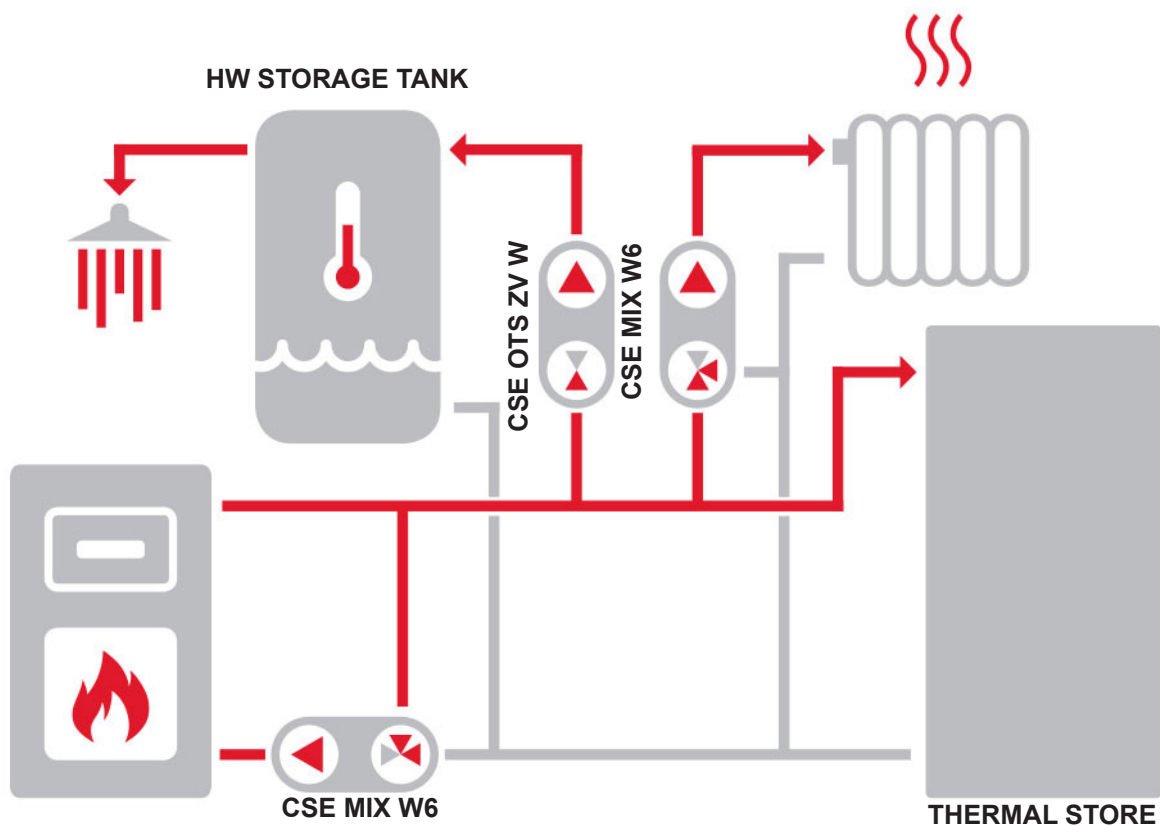

#### Example of possible connection II

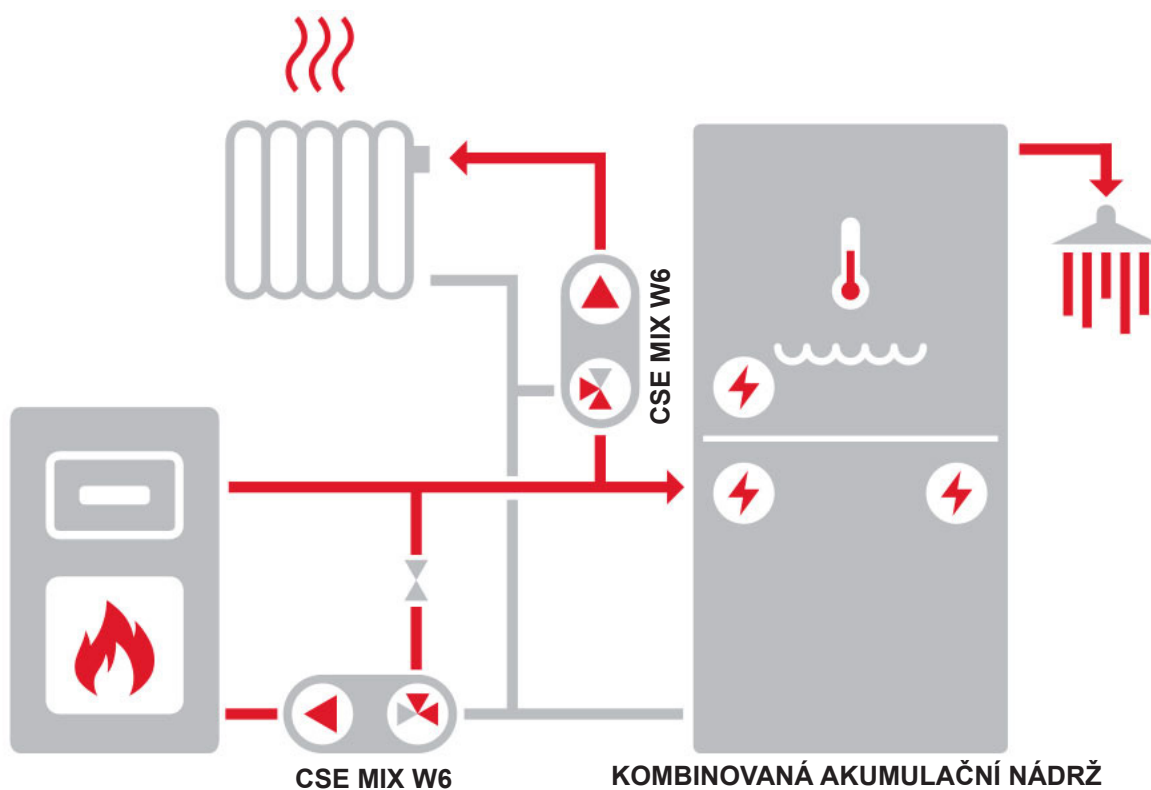

## 4. Mixing Valve Actuator



Technical data	
Torque	5 Nm
Angle of rotation	90°
Shift time	120 s
Control	3-point (SPDT)
Auxiliary switch	none
Power supply	230 V AC
Max. power input	2.5 VA
IP rating	IP42
Protection class	II by EN 60730-1
Cable (cross section area - length)	3 x 0.5 mm <sup>2</sup> - 2 m

### actuator wiring

- marking 1, 2, 3 located on the cables

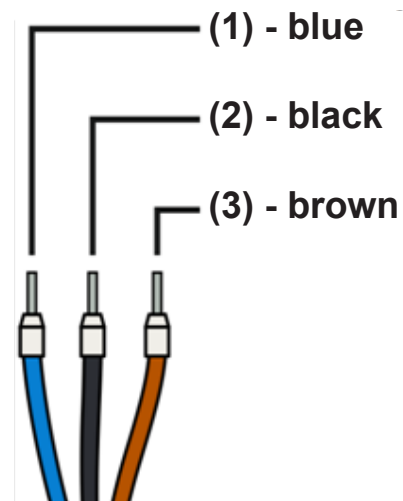
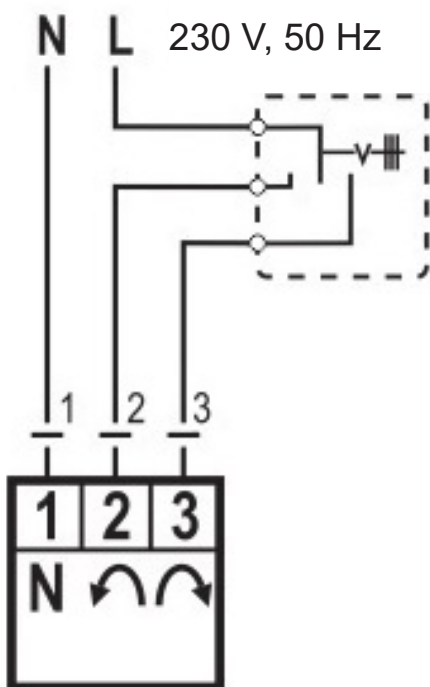

## 5. PARA 25/8 SC Pump

### 5.1. General Information



The high efficiency circulation pumps of the PARA SC series are used exclusively for the circulation of liquids in hot water heating systems. Operating the pump in other systems or in systems lacking water, containing air or in unpressurized systems can lead to its rapid destruction.

### 5.2. Pump Description

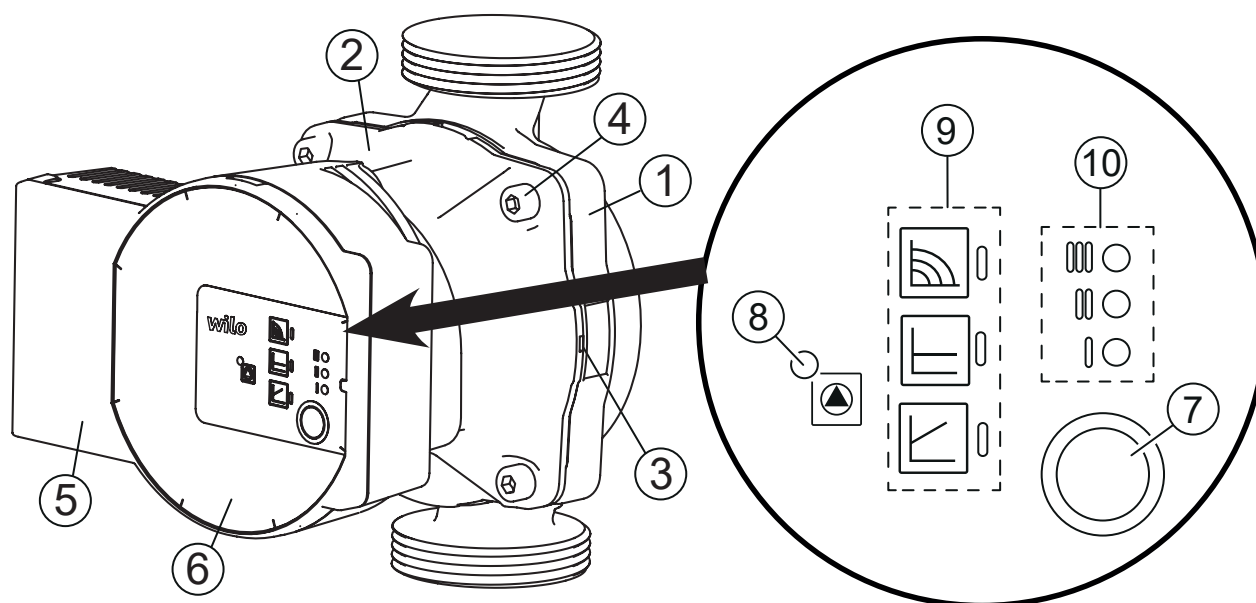

- 1 - Pump housing
- 2 - Pump motor
- 3 - Condensate drain openings
- 4 - Pump housing bolts
- 5 - Control module
- 6 - Rating plate
- 7 - Pump adjustment button
- 8 - LED indication of operation/fault
- 9 - Display of the selected pump operating mode
- 10 - Display of the selected pump curve (I, II, III)

### 5.3. Permitted and Prohibited Pump Positions

The pump station may be installed either horizontally or vertically.

#### Permitted positions



#### Prohibited positions

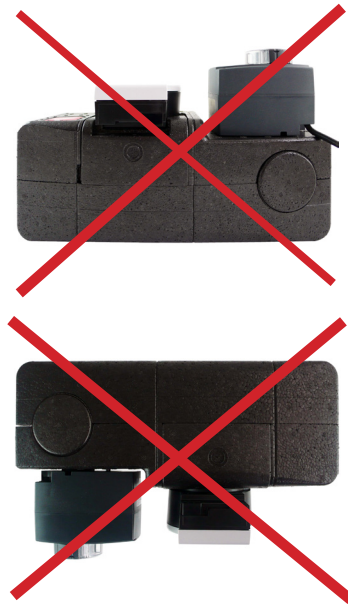

### 5.4. Pump Wiring

The pump shall be wired to / disconnected from electrical installation by a qualified person in compliance with EN 50110-1!

Plug the power cable (2) into the connector on the pump so that the connector lock (1) is in the correct position, see Fig.

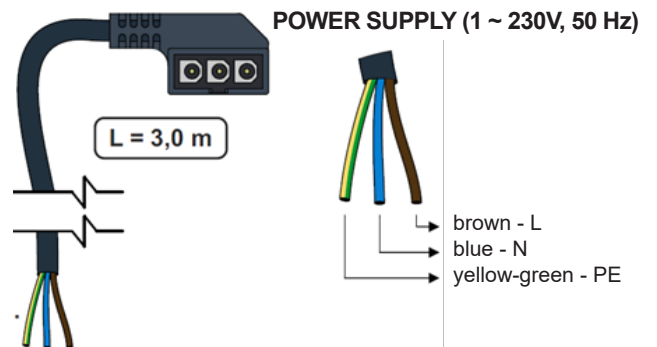
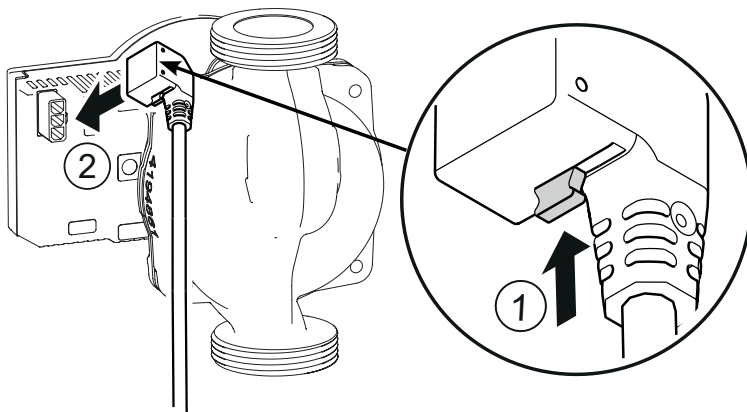

- 1 Lock
- 2 Power cable connector



## 5.5. Pump Control

Constant speed operating mode and pump performance curve III are preset as factory settings for the PARA SC pump. After switching on, the pump runs at the factory setting or at the last setting.

The settings can be changed using the operating button, see below.

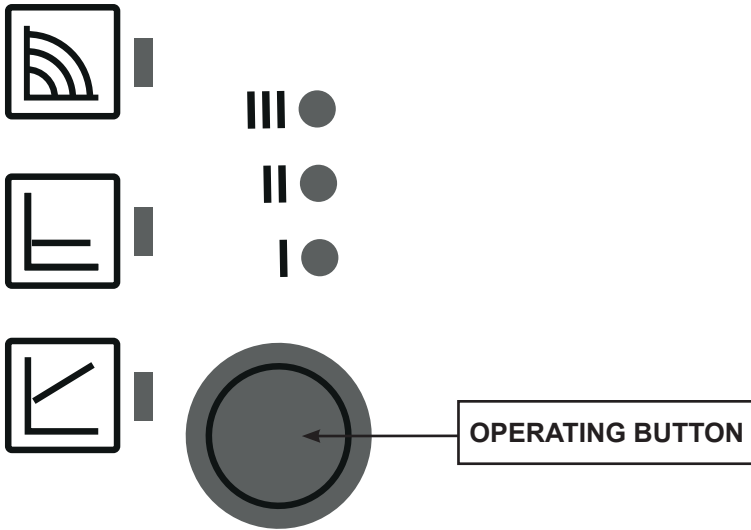

### Briefly press the operating button to:

select the pump operating mode: constant speed,  $\Delta p$ -v or  $\Delta p$ -c and the pump performance curve (I, II, III)

### Press and hold the operating button for the specified time to activate:

- **Pump venting function** - hold the control button for 3 seconds.
- **Manual restart** - hold the operating button for 5 seconds.
- **Locking / Unlocking the operating button** - hold the button for 8 seconds.
- **Factory setting** - hold the control button for at least 4 seconds and switch off the pump by disconnecting it from the mains.

## SETTING THE PUMP PROFILE

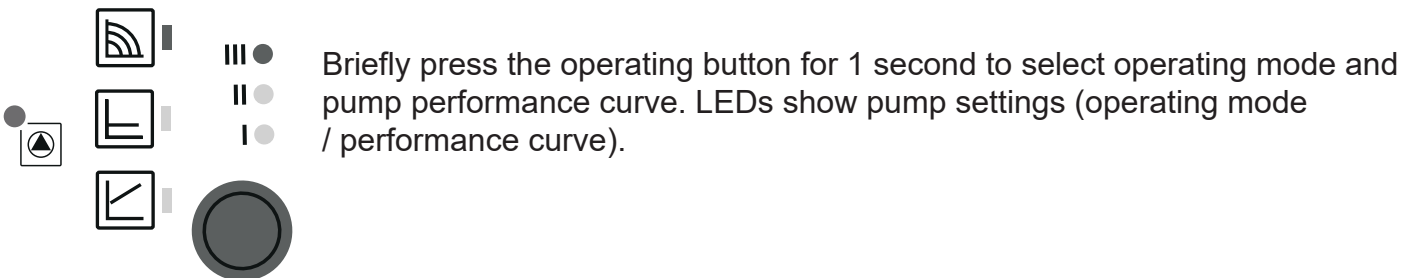

	LED indicators	Operating mode	Performance curve
1		constant speed	II
2		constant speed	I
3		$\Delta p$ -v variable	III
4		$\Delta p$ -v variable	II
5		$\Delta p$ -v variable	I
6		$\Delta p$ -c constant	III
7		$\Delta p$ -c constant	II
8		$\Delta p$ -c constant	I
9		constant speed	III

## PUMP VENTING

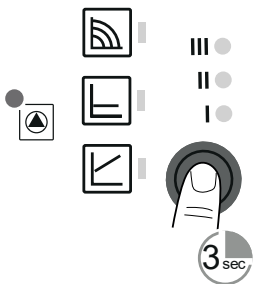

### If air is present in the pump:

- o Activate the pump venting function by pressing and holding the operating button for 3 sec. The upper and lower rows of LEDs will flash in 1sec interval, see Fig.
- o Pump venting takes 10 minutes, after that the pump returns to current mode. In order to cancel pump venting, press and hold the operating button for 3 sec.

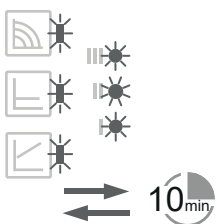



## MANUAL RESTART

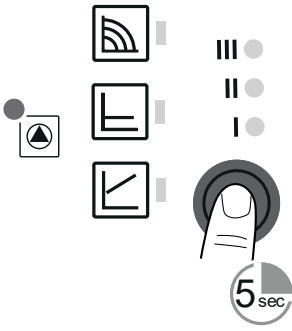

If the pump has been inactive for a long time or is blocked, activate the manual restart by holding the operating button for 5 seconds. The LEDs flash sequentially clockwise. The manual restart takes max. 10 minutes before the pump returns to normal operation. To cancel the manual restart, hold down the operating button for 5 seconds.

If the pump does not get unblocked, contact a qualified technician.

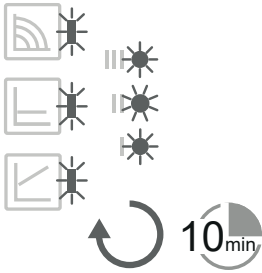

## OPERATING BUTTON LOCKING / UNLOCKING

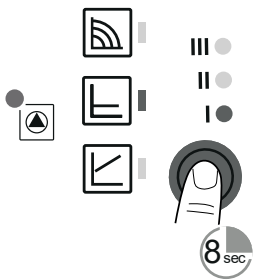

To lock the operating button, press it for 8 seconds.

The selected setting then starts flashing and cannot be changed. To unlock, hold down the operating button again for 8 seconds and the LEDs will stop flashing.



## FACTORY SETTINGS

To return to the factory settings, press and hold the operating button for at least 4 sec. (all LEDs flash for 1 second) and turn off the pump by unplugging. When switched on again, the pump will run at the factory settings.

# PUMP OPERATING MODES



## Variable differential pressure $\Delta p-v$

**It is not recommended to use variable differential pressure for solid fuel boiler pumps!**

The Variable differential pressure operating mode is recommended in systems where it is advisable to reduce the discharge pressure of the pump in parallel with the decreasing required flow rate. A typical example is a heating circuit with radiators equipped with thermostatic valves, where the selection of this operating mode can reduce the noise from thermostatic valves which is caused by closing too many radiators in the system. This mode, on the other hand, is unsuitable for circuits with heat sources where the reduction of the head and flow can make these sources even inoperable.

By reducing the discharge as the flow decreases, the pump's power consumption and therefore the operating costs are significantly reduced (see graph Q-P). In larger heating circuits and in circuits where there are significant differences in heating demand in separate heating zones, this mode may temporarily cause insufficient heating. In these systems, it may be preferable to switch the pump to  $\Delta p-c$  mode.

### Performance curves

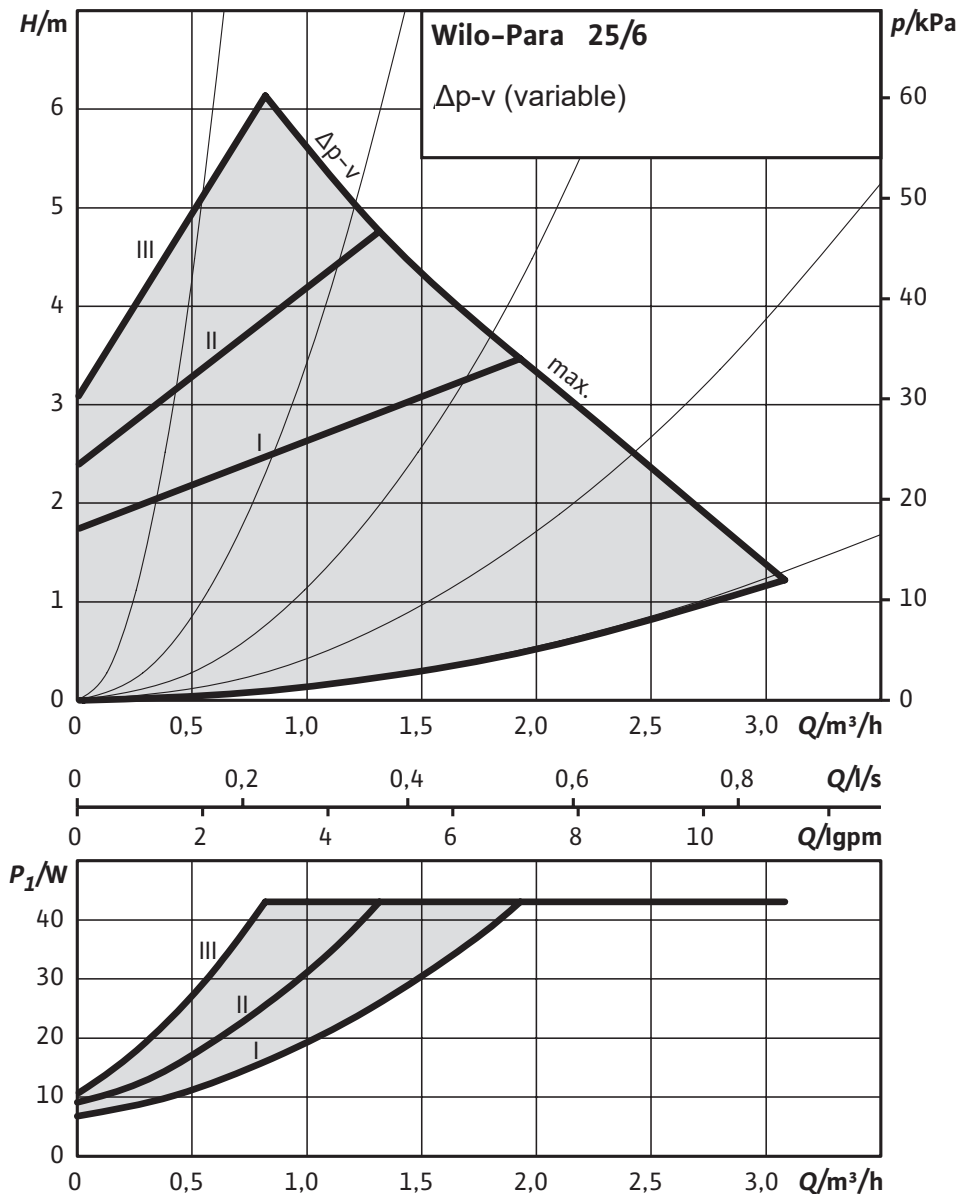



## Constant differential pressure $\Delta p$ -c

The Constant differential pressure (constant delivery head) operating mode is suitable for hydraulic circuits of heat sources (boilers, heat pumps, solar thermal systems etc.), hot water storage tanks, heaters, underfloor heating systems and large heating circuits where the previous mode  $\Delta p$ -v could cause insufficient heating through discharge reduction.

By decreasing the required flow, the pump maintains a constant delivery head, thus the pump power consumption decrease is more gentle than in the  $\Delta p$ -v mode.

### Performance curves

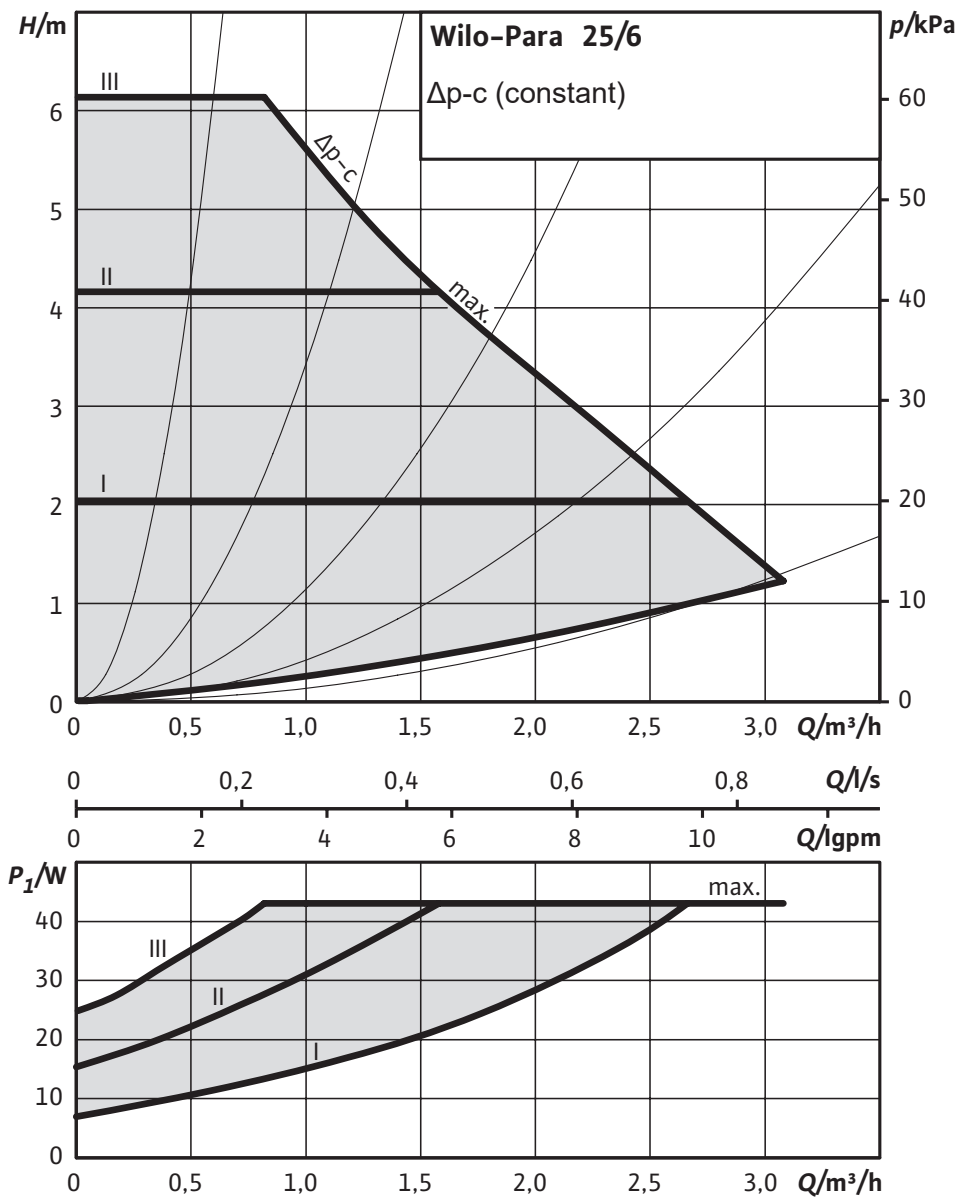



## Constant speed

Constant speed operating mode means that the pump does not adjust its speed in any way depending on the flow rate or discharge of the hydraulic circuit. The flow and discharge of the pump are thus entirely dependent on the speed setting set (I, II, III) and the hydraulic circuit settings. This mode is used when the more economical  $\Delta p$ -c mode is not suitable. This is the same mode as in the older types of classic circulation pumps where the speed I, II, III was set by a selector switch.

For example, this mode may be suitable for older circuit types where flow is regulated by throttling and this method required to be maintained. Furthermore, it may be suitable for solid fuel boilers that are equipped with older types of TSV valves with balancing using a manual throttle valve, or in other similar specific cases of requiring a constant pump performance.

### Performance curves

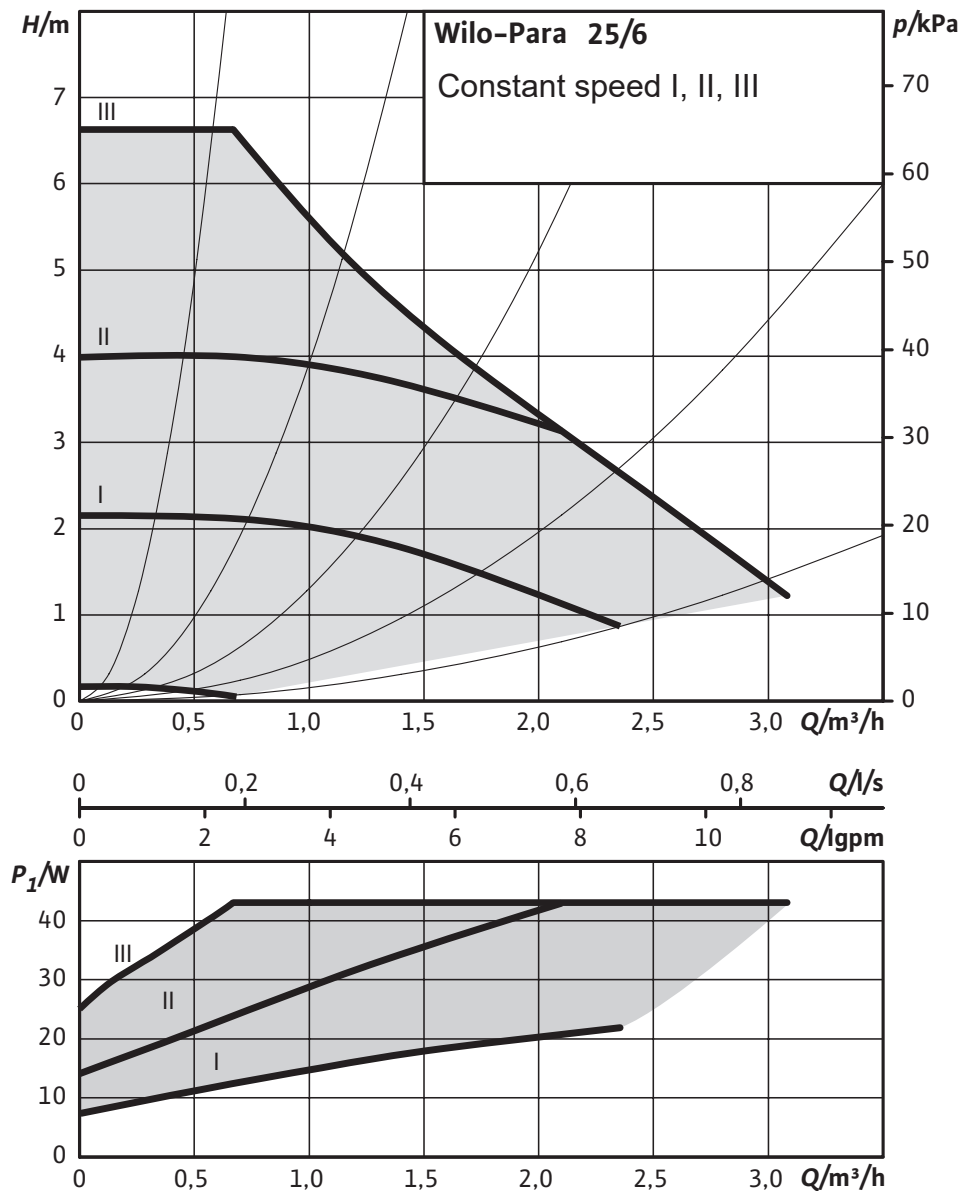





## 5.6. Technical Data

<b>Wilo PARA 25/6 SC</b>	
<b>Electric Data</b>	
Power supply	1 ~ 230 V, 50 - 60 Hz
Power input (min./max.)	2 / 43 W
Current (min./max.)	0.03 / 0.44 A
Max. speed	4300 rpm
Speed control	frequency converter
Energy Efficiency Index	≤ 0,21 by EN 16 297/3
IP rating	IPX4D
Motor protection	integrated

## 5.7. FAULTS, THEIR REASONS AND TROUBLESHOOTING

 The LED light signals a defect. The pump will switch off (depending on the defect type) and try to restart.

LED indication		state description and possible fault reasons
	green is lit	1 - pump is running in trouble-free operation
	red is lit	1 - rotor is blocked 2 - electric motor winding defect
	flashing red	1 - power supply lower/higher than 230 V 2 - electric short circuit in pump 3 - pump overheated
	flashing red and green	1 - unforced fluid circulation through the pump 2 - pump speed lower than desired 3 - air in pump

FAULTS	REASONS	TROUBLESHOOTING
Pump does not run despite power supply switched on	Faulty el. fuse	Check fuses
	Pump is not energized	Remove voltage interruption
Pump is making noise	Cavitation due to insufficient inlet pressure	Increase the pressure in the device within the permissible range
		Check the head setting, or set a lower head
Building not warming up	Heat output of heating surfaces too low	Increase the desired value
		Set the operating mode to $\Delta p-c$

If the fault cannot be rectified, contact a specialized technician.

## 6. Installation options

The pump station comes with a mixing valve in the left-hand position (see Fig. 1). If this installation position is convenient, there is no need to make any adjustments. If you remove the actuator during installation, do not turn the valve control manually and refit the actuator in the same position. When needed, the mixing valve can be rotated to the right-hand position (see Fig. 2). After the valve is turned by 180° and the fittings tightened, the actuator lock shall be unscrewed and screwed into the opening at the other valve side (see Fig. 2), and the position of the valve member and of the actuator changed (see the paragraph and pictures below).

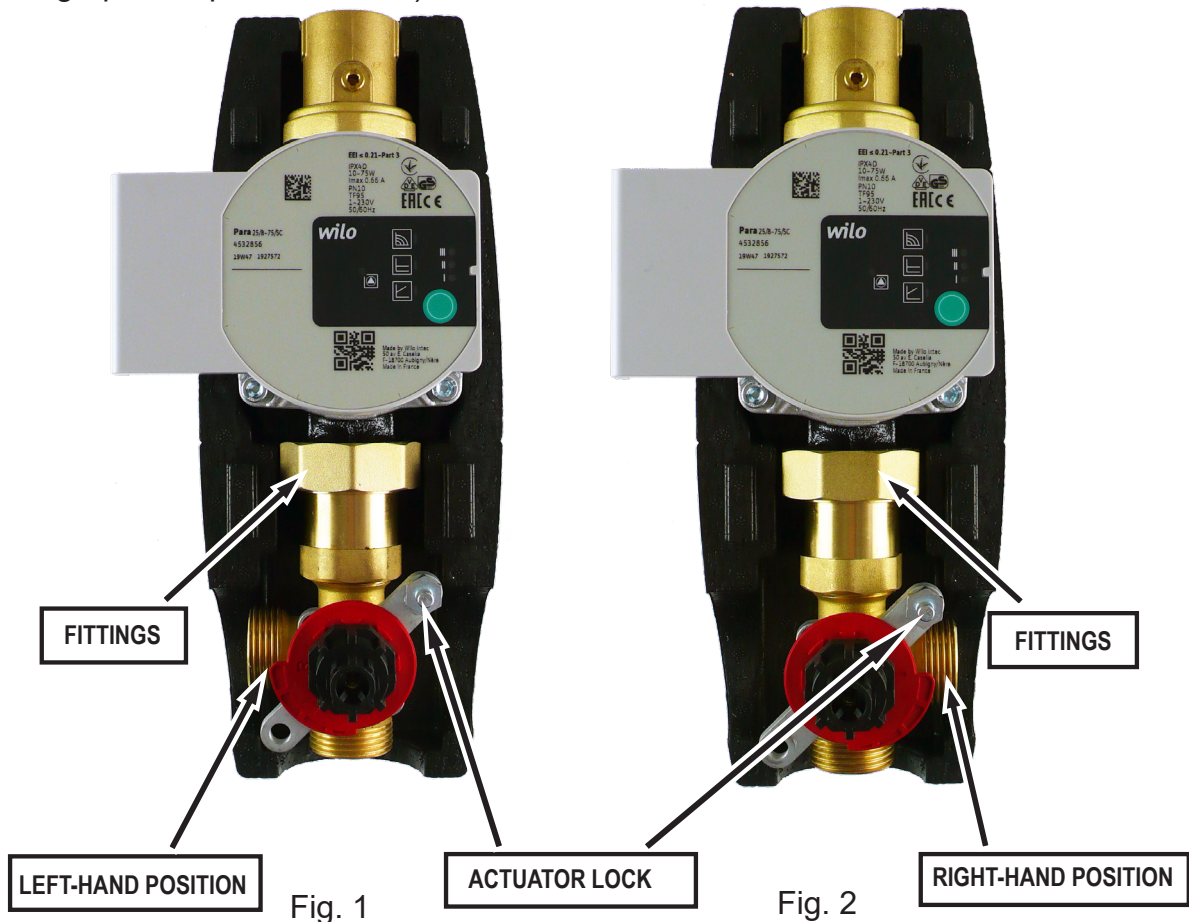

### Actuator adjustment

Having turned the valve to the right hand position, turn the D-shaft in such a manner that the valve member is between inlets 1 and 3, turn the red plastic wheel properly (see Fig. 4) and finally fit the plastic adapter (the arrow on the plastic adapter forms an angle of 45° with inlets 1 and 3, see Fig. 4). **The flat spot on the shaft and the arrow on the plastic adapter shall be on the same side as the valve member!**

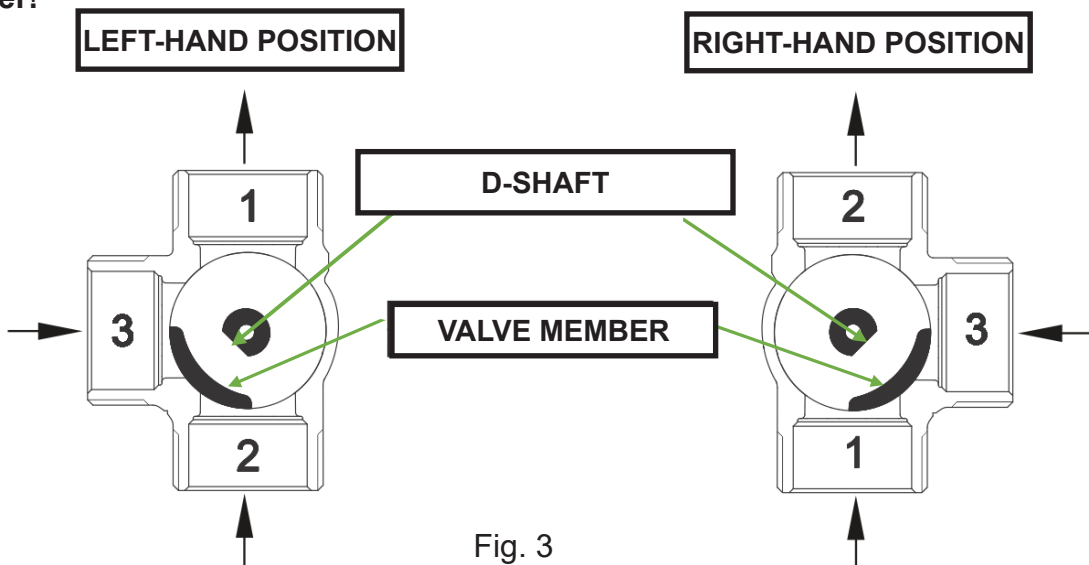

Fig. 3



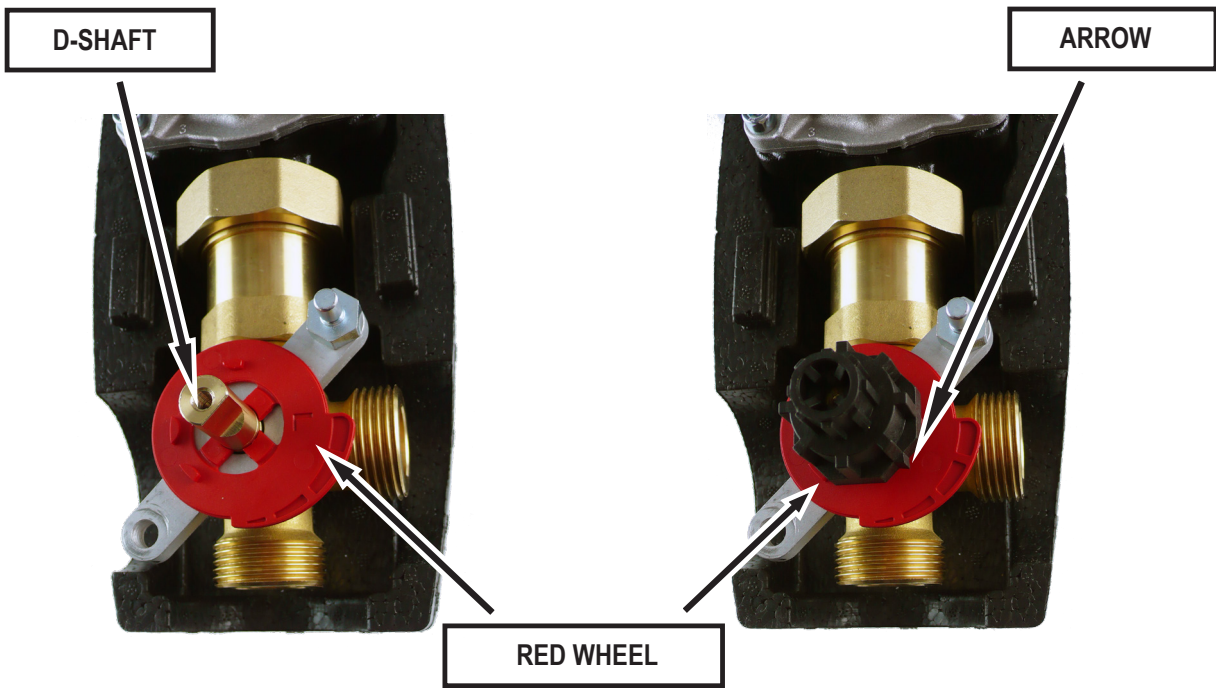
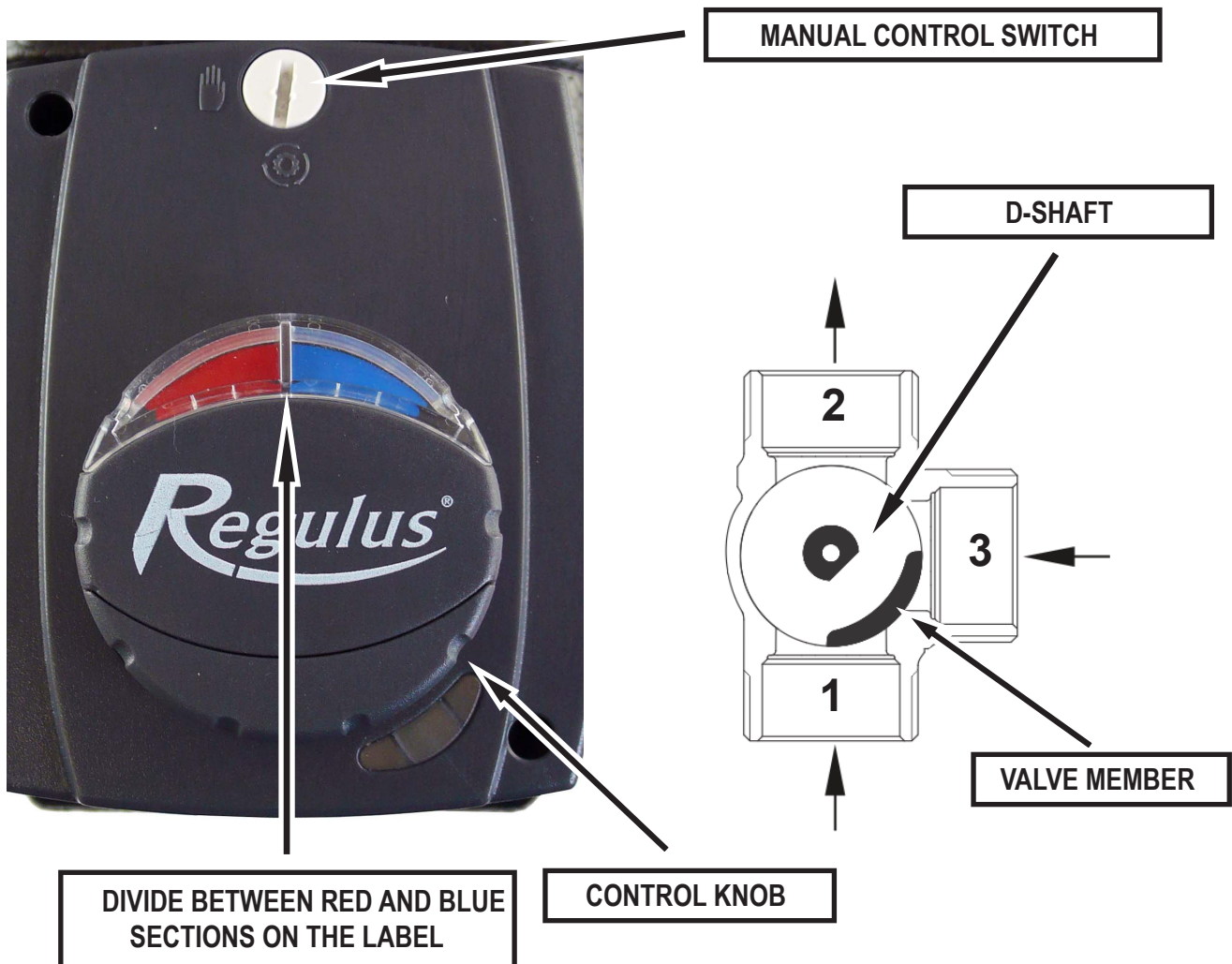

Fig. 4

Prior to fitting the actuator on the plastic adapter, switch it to manual control, set the control knob to the middle of its control range (i.e. to the divide between red and blue on the label) and then fit the actuator onto the adapter already on the valve. The control knob shall be able to turn freely both to left and right by 45°. When turned to the right by 45°, the path 1 is closed, and when turned to the left by 45° the path 3 is closed. Having performed the check, turn the knob back to automatic control.





After the actuator is fitted, the correct position of the round indication label (hot/cold, red/blue) shall be checked as to the right function and position of the valve; the colours shall correspond to the cold and hot water connections. In case of a vertical installation in central heating, the red mark on the label shall be on the right-hand side for left-hand installations (see Fig. 5) and on the left-hand side for right-hand installations (see Fig. 6).

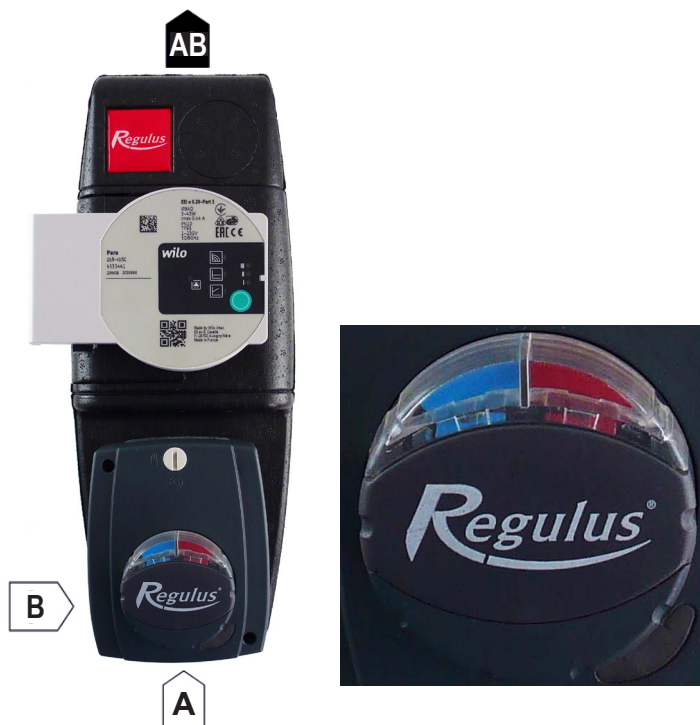

Fig. 5



Fig. 6

In case of a horizontal installation with a solid fuel boiler, the red mark on the label shall be on the right-hand side for right-hand installations (boiler to the left from the pump station, see Fig. 7) and on the left-hand side for left-hand installations (boiler to the right from the pump station, see Fig. 8).

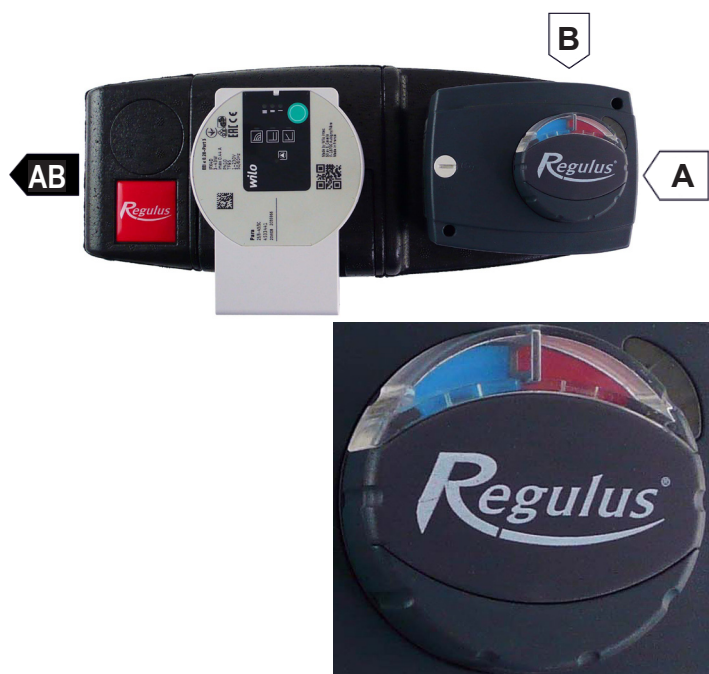

Fig. 7

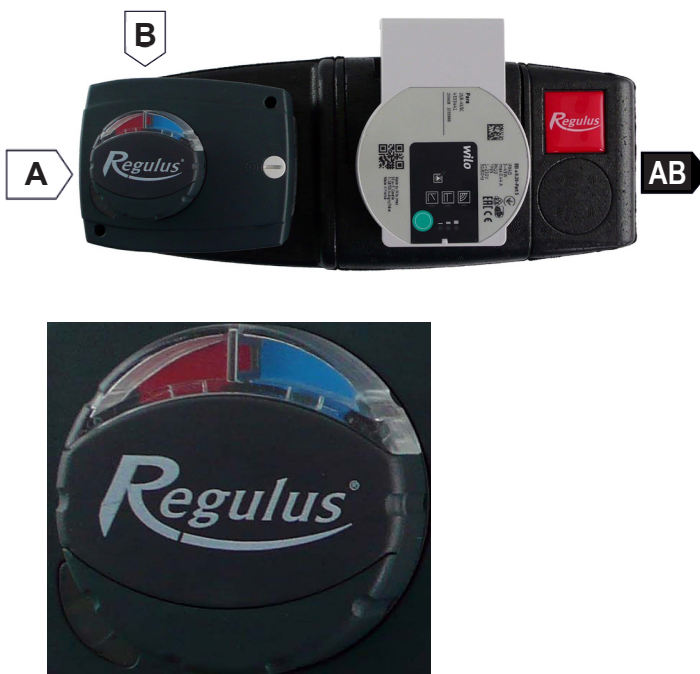

Fig. 8