



CSE OTS ZV W8-SC

Installation and Operation Manual  
**CSE OTS ZV W8-SC PUMP STATION**  
with non-return valve, for heating systems

EN

# 1. Introduction

CSE OTS ZV W8-SC pump station is designed to be installed in unmixed hydraulic circuits in heating systems where a non return valve is required. The pump station provides circulation through the concerned heating circuit, preventing circulation in the opposite direction.

# 2. Description of the pump station

The pump station consists of a Wilo Yonos PARA 28/8 SC pump including a power cable, a ball valve with a non-return valve, fittings with a ball shut-off valve, thermometer and insulation.

Main features	
Application	on a flow pipe in heating systems
Description	consists of a Wilo Para 25/8 SC pump, a ball valve with a non-return valve, fittings with a ball valve, thermometer and insulation
Working fluid	water, water-glycol mixture (max. 1:1) or water-glycerine mixture (max. 2:1)
Installation	on a flow pipe in heating systems, the min. distance of the pipe axis from a wall is 100 mm
Code	<b>17979</b>

Technical data of CSE OTS ZV W8-SC pump station	
Fluid working temperature	5 - 90 °C
Max. working pressure	10 bar
Min. working pressure	0.5 bar
Ambient temperature	5 - 40 °C
Max. rel. humidity	80 % non condensing
Insulation material	EPP RG 60 g/l
Overall dimensions	305 x 165 x 170 mm
Total weight	2.8 kg
Connections	2x G 1" F

### 3. Flow direction



## 4. Wilo-Para SC Pump

### 4.1. General Information



The high efficiency circulation pumps of the PARA SC series are used exclusively for the circulation of liquids in hot water heating systems. Operating the pump in other systems or in systems lacking water, containing air or in unpressurized systems can lead to its rapid destruction.

## 4.2. Pump Description

- 1 - Pump housing
- 2 - Pump motor
- 3 - Condensate drain openings
- 4 - Pump housing bolts
- 5 - Control module
- 6 - Rating plate
- 7 - Pump adjustment button
- 8 - LED indication of operation/fault
- 9 - Display of the selected pump operating mode
- 10 - Display of the selected pump curve (I, II, III)

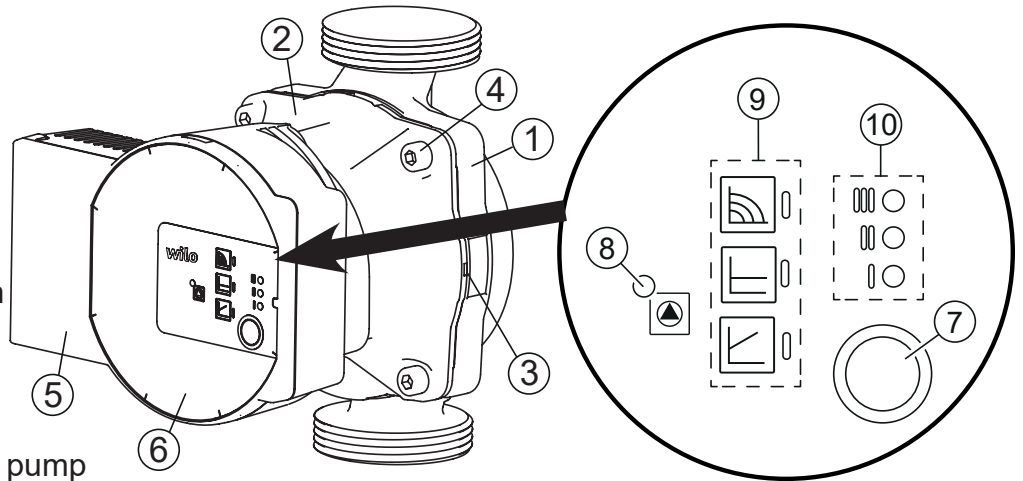

## 4.3. Permitted and Prohibited Pump Positions

Permitted Pump Positions



Prohibited Pump Positions

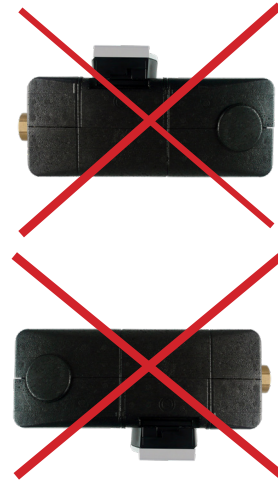

## 4.4. Pump Wiring

The pump must be wired / disconnected by a qualified person in compliance with EN 50110-1!

Plug the power cable (2) into the connector on the pump so that the connector lock (1) is in the correct position, see Fig.

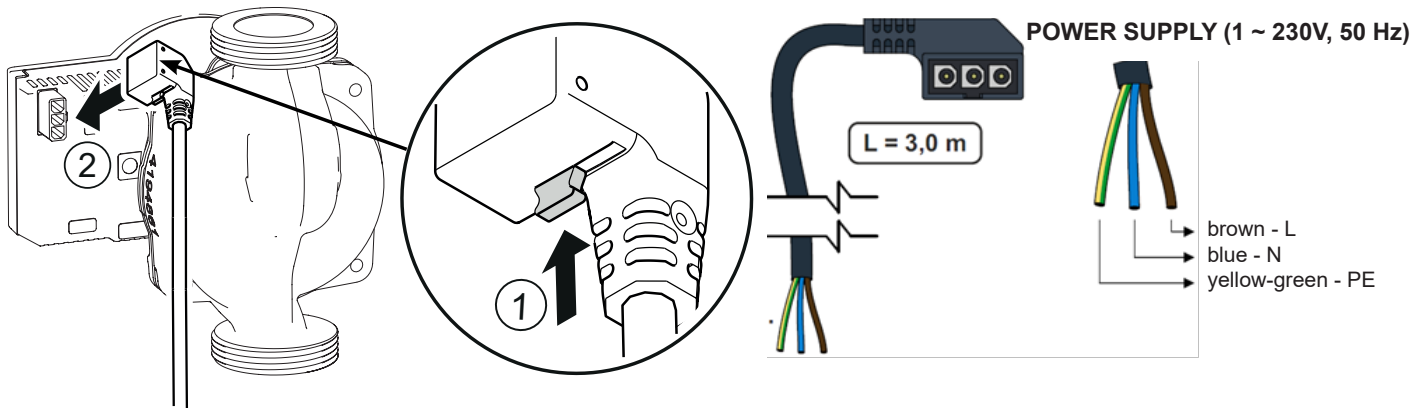

- 1 Lock
- 2 Power cable connector

## 4.5. Pump Control

Constant speed operating mode and pump performance curve III are preset as factory settings for the PARA SC pump. After switching on, the pump runs at the factory setting or at the last setting.

The settings can be changed using the operating button, see below.

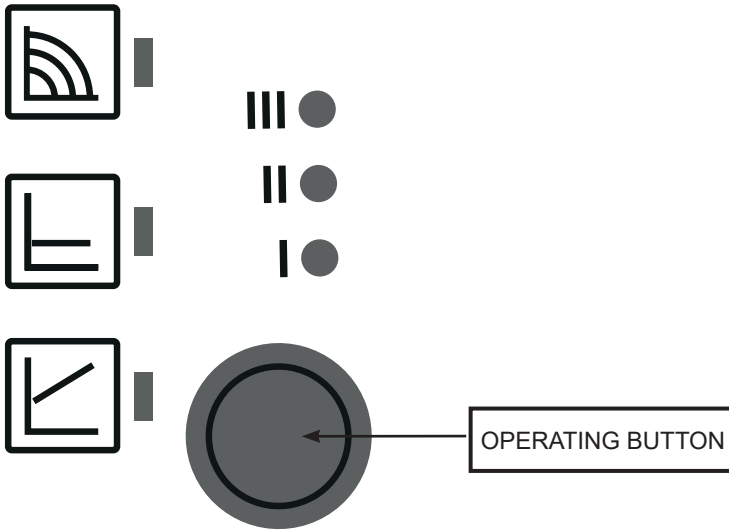

### Briefly press the control button to:

select the pump operating mode: constant speed,  $\Delta p$ -v or  $\Delta p$ -c and the pump performance curve (I,II,III)

### Press and hold the operating button for the specified time to activate:

- **Pump venting function** - hold the control button for 3 seconds.
- **Manual restart** - hold the operating button for 5 seconds.
- **Locking / Unlocking the operating button** - hold the button for 8 seconds.
- **Factory setting** - hold the control button for at least 4 seconds and switch off the pump by disconnecting it from the mains.

## SETTING THE PUMP PROFILE

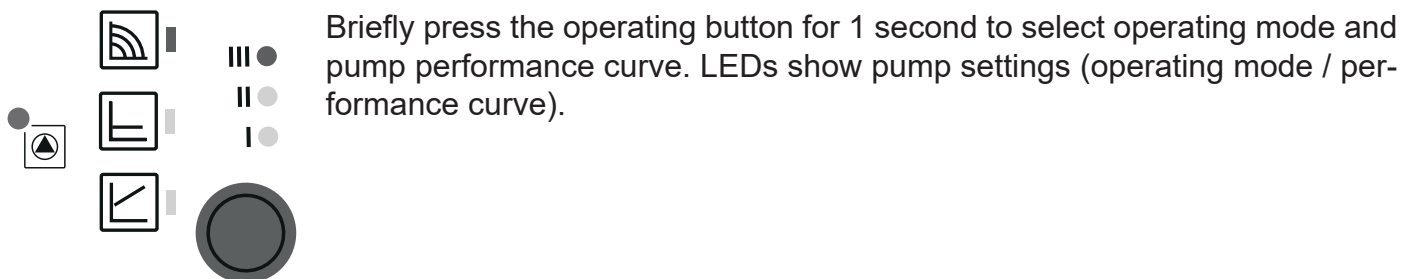

	LED indicators	Operating mode	Performance curve
1		constant speed	II
2		constant speed	I
3		$\Delta p$ -v variable	III
4		$\Delta p$ -v variable	II
5		$\Delta p$ -v variable	I
6		$\Delta p$ -c constant	III
7		$\Delta p$ -c constant	II
8		$\Delta p$ -c constant	I
9		constant speed	III

## PUMP VENTING

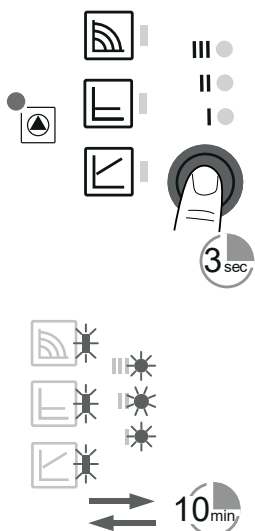

### If air is present in the pump:

- o Activate the pump venting function by pressing and holding the operating button for 3 sec. The upper and lower rows of LEDs will flash in 1sec interval, see Fig.
- o Pump venting takes 10 minutes, after that the pump returns to current mode. In order to cancel pump venting, press and hold the operating button for 3 sec.

## MANUAL RESTART

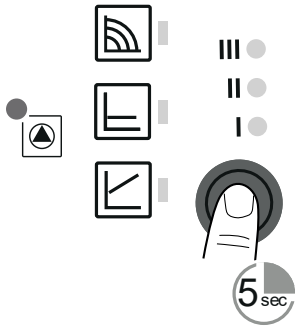

If the pump has been inactive for a long time or is blocked, activate the manual restart by holding the operating button for 5 seconds. The LEDs flash sequentially clockwise. The manual restart takes max. 10 minutes before the pump returns to normal operation. To cancel the manual restart, hold down the operating button for 5 seconds.

If the pump does not get unblocked, contact a qualified technician.

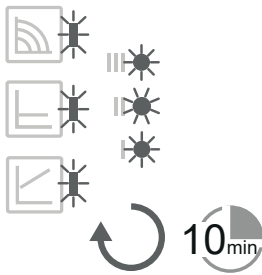

## OPERATING BUTTON LOCKING / UNLOCKING

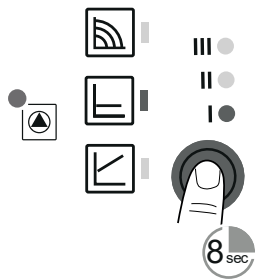

To lock the operating button, press it for 8 seconds.

The selected setting then starts flashing and cannot be changed. To unlock, hold down the operating button again for 8 seconds and the LEDs will stop flashing.



## FACTORY SETTINGS

To return to the factory settings, press and hold the operating button for at least 4 seconds (all LEDs flash for 1 second) and turn off the pump by unplugging. When switched on again, the pump will run at the factory settings.

# PUMP OPERATING MODES



## Variable differential pressure $\Delta p-v$

**It is not recommended to use variable differential pressure for solid fuel boiler pumps!**

The Variable differential pressure operating mode is recommended in systems where it is advisable to reduce the discharge pressure of the pump in parallel with the decreasing required flow rate. A typical example is a heating circuit with radiators equipped with thermostatic valves, where the selection of this operating mode can reduce the noise from thermostatic valves which is caused by closing too many radiators in the system. This mode, on the other hand, is unsuitable for circuits with heat sources where the reduction of the head and flow can make these sources even inoperable. By reducing the discharge as the flow decreases, the pump's power consumption and therefore the operating costs are significantly reduced (see graph Q-P). In larger heating circuits and in circuits where there are significant differences in heating demand in separate heating zones, this mode may temporarily cause insufficient heating. In these systems, it may be preferable to switch the pump to  $\Delta p-c$  mode.

### Performance curves

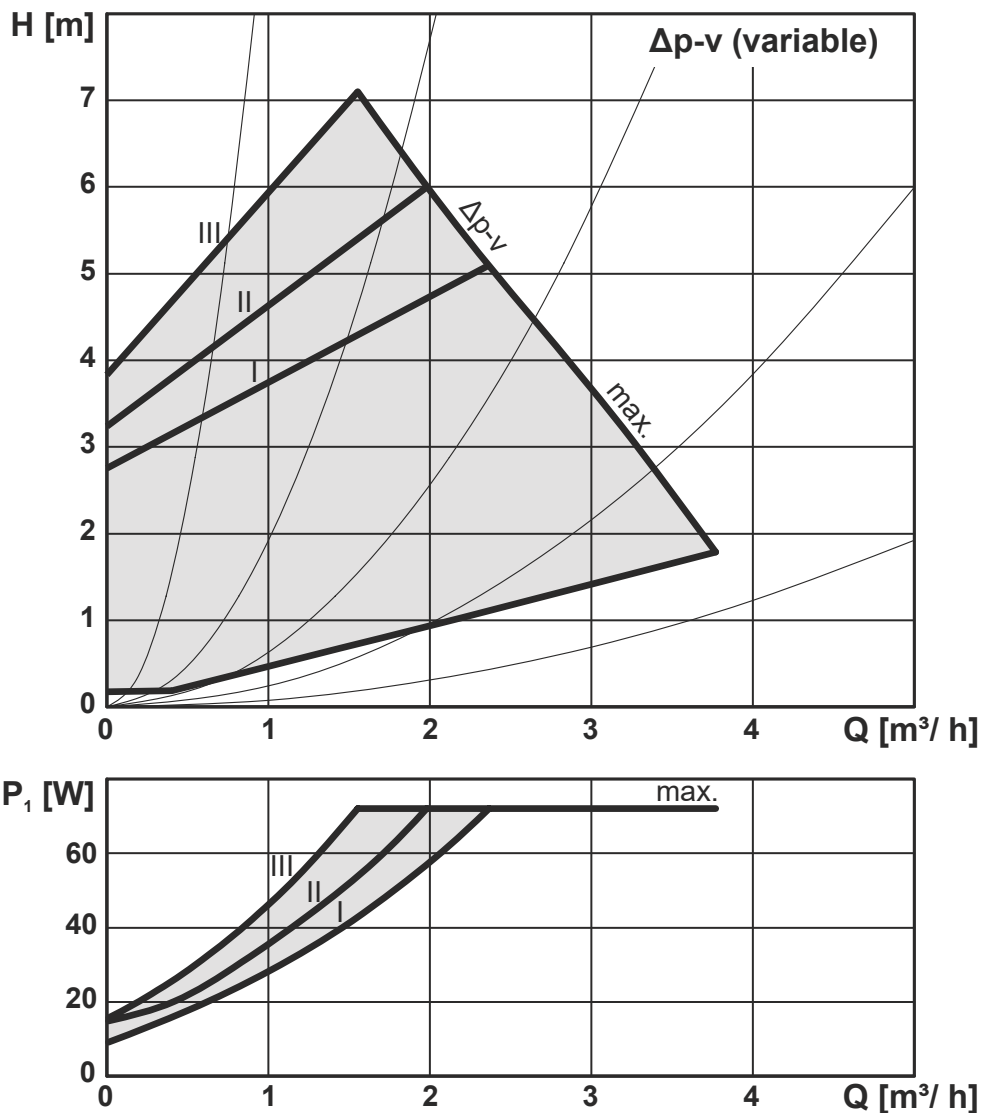





## Constant differential pressure $\Delta p$ -c

The Constant differential pressure (constant delivery head) operating mode is suitable for hydraulic circuits of heat sources (boilers, heat pumps, solar thermal systems etc.), hot water storage tanks, heaters, underfloor heating systems and large heating circuits where the previous mode  $\Delta p$ -v could cause insufficient heating through discharge reduction.

By decreasing the required flow, the pump maintains a constant delivery head, thus the pump power consumption decrease is more gentle than in the  $\Delta p$ -v mode.

### Performance curves

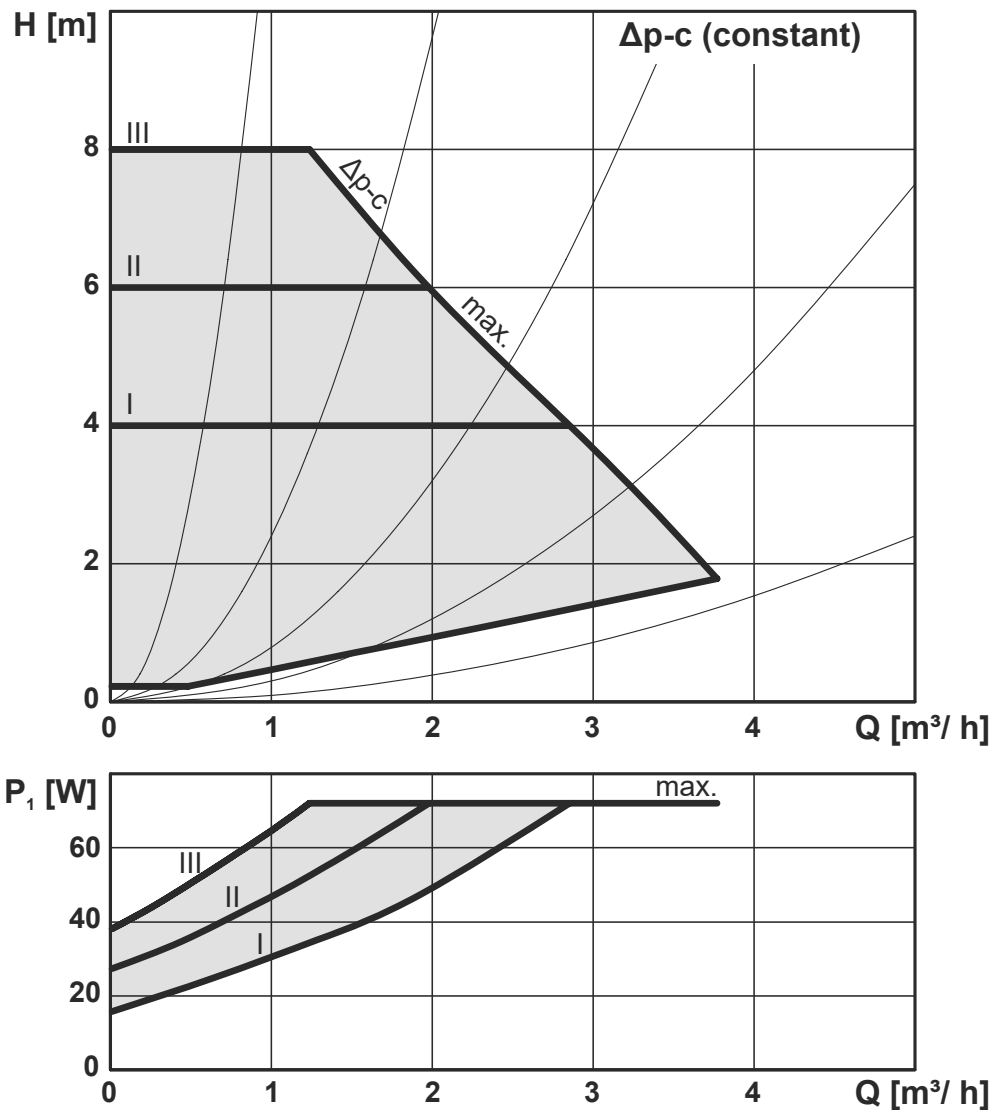



## Constant speed

Constant speed operating mode means that the pump does not adjust its speed in any way depending on the flow rate or discharge of the hydraulic circuit. The flow and discharge of the pump are thus entirely dependent on the speed setting set (I, II, III) and the hydraulic circuit settings. This mode is used when the more economical  $\Delta p$ -c mode is not suitable. This is the same mode as in the older types of classic circulation pumps where the speed I, II, III was set by a selector switch.

For example, this mode may be suitable for older circuit types where flow is regulated by throttling and this method required to be maintained. Furthermore, it may be suitable for solid fuel boilers that are equipped with older types of TSV valves with balancing using a manual throttle valve, or in other similar specific cases of requiring a constant pump performance.

### Performance curves

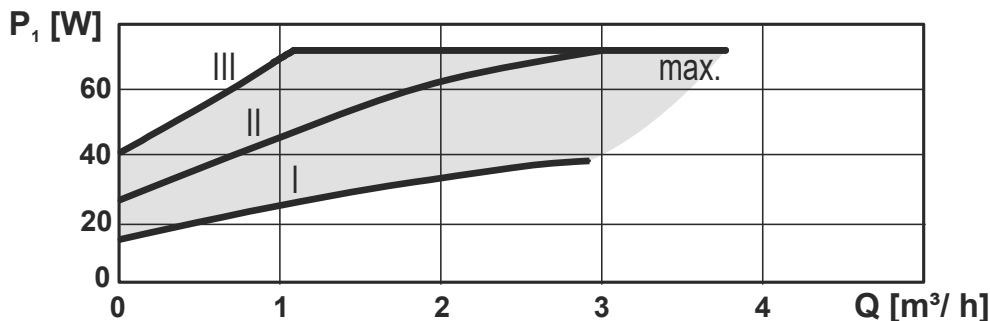
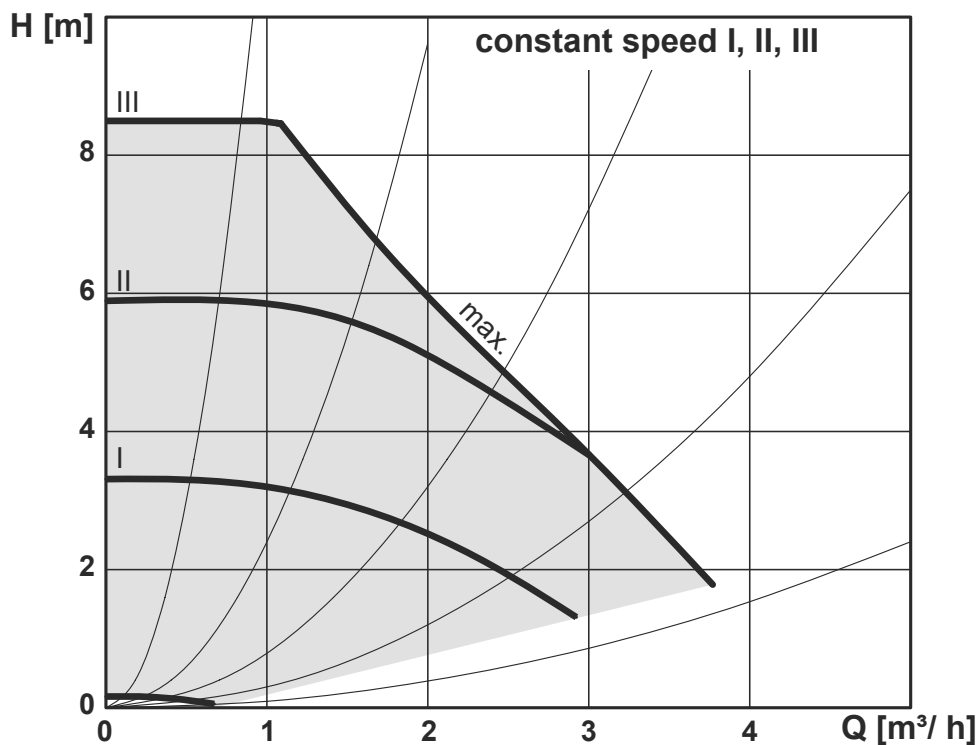





## 4.6. Technical Data

<b>PARA 25/8 SC</b>	
<b>Electric Data</b>	
Electric Data	1 ~ 230 V, 50 - 60 Hz
Power input (min./max.)	2 / 75 W
Current (min./max.)	0.03 / 0.66 A
Max. speed	4800 rpm
Speed control	frequency converter
Energy Efficiency Index	$\leq 0.21$ dle EN 16 297/3
IP rating	IPX4D
Motor protection	integrated
Max. head	8.4 m

## 4.7. FAULTS AND THEIR REASONS

 The LED light signals a defect. The pump will switch off (depending on the defect type) and try to restart.

LED signals	State description and possible fault reasons
 GREEN IS LIT	1 - pump is running in trouble-free operation
 RED IS LIT	1 - rotor is blocked 2 - electric motor winding defect
 FLASHING RED	1 - power supply lower/higher than 230 V 2 - electric short circuit in pump 3 - pump overheated
 FLASHING RED AND GREEN	1 - unforced fluid circulation through the pump 2 - pump speed lower than desired 3 - air in pump

FAULTS	REASONS	TROUBLESHOOTING
Pump does not run despite power supply switched on	El. fuse defect	Check the fuses
	Pump not energized	Remove power supply interruption
Pump is making noise	Cavitation due to insufficient inlet pressure	Increase pressure in the device within permissible range
		Check head setting, if necessary, set lower head
Building not warming up	Heat output of heating surfaces too low	Increase the desired value
		Set the operating mode to $\Delta p-c$

If the fault cannot be rectified, contact a qualified technician.